

ROECO

Bearing Data

Ball Bearing Units

Bearing No. : **UP002**

Dimensions

H = 22
L = 80
J = 63
N = 7
H1 = 7
H2 = 43

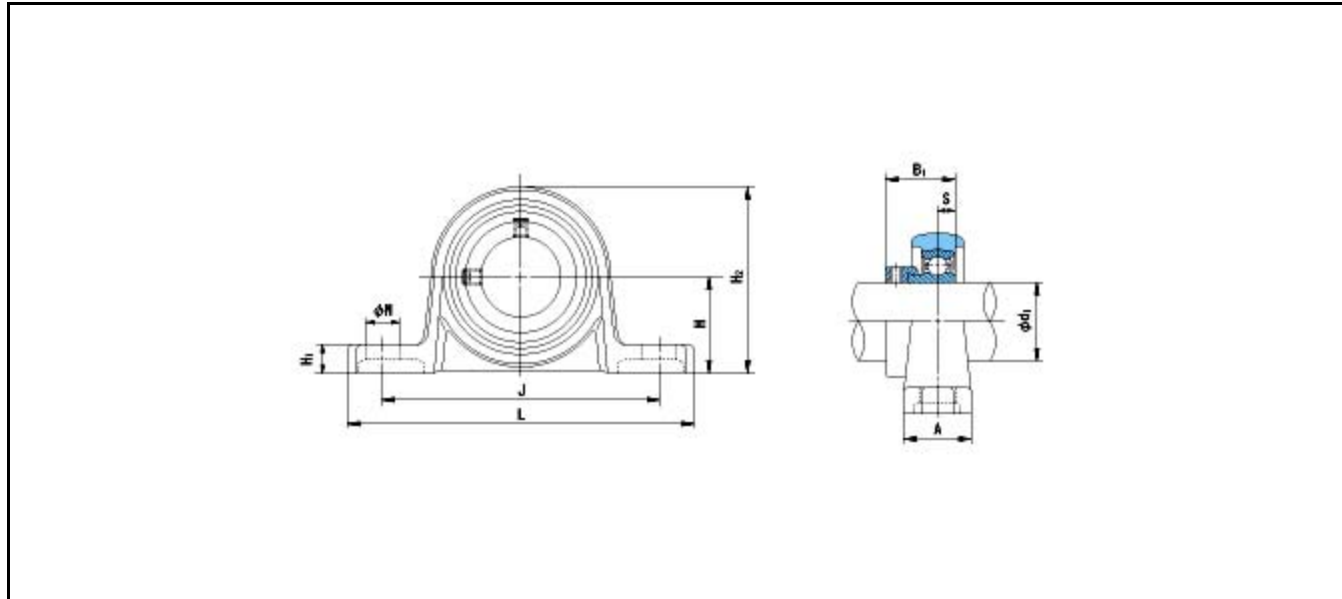

Dimensions

d1 = 15
A = 16
B1 = 18.5
S = 4.5
Mass = 125 g

Basic Dynamic Load Rating Cr :	5600 N			
Basic Static Load Rating Cor :	2800 N	O.D.Surface Runout with Side :		-
Limiting Speed ;		Axial Runout with Bore :		-
Grease Lubrication :	- rpm	Axial Runout with Raceway :		-
Oil Lubrication :	- rpm	Width Variation :		-
		Radial Runout :		-