

ROECO

Bearing Data

Ball Bearing Units

Bearing No. : **UKTX11+H2311**

Dimensions

H = 146

H2 = 102

L = 194

L1 = 119

L2 = 19

L3 = 102

N = 35

N1 = 32

N2 = 64

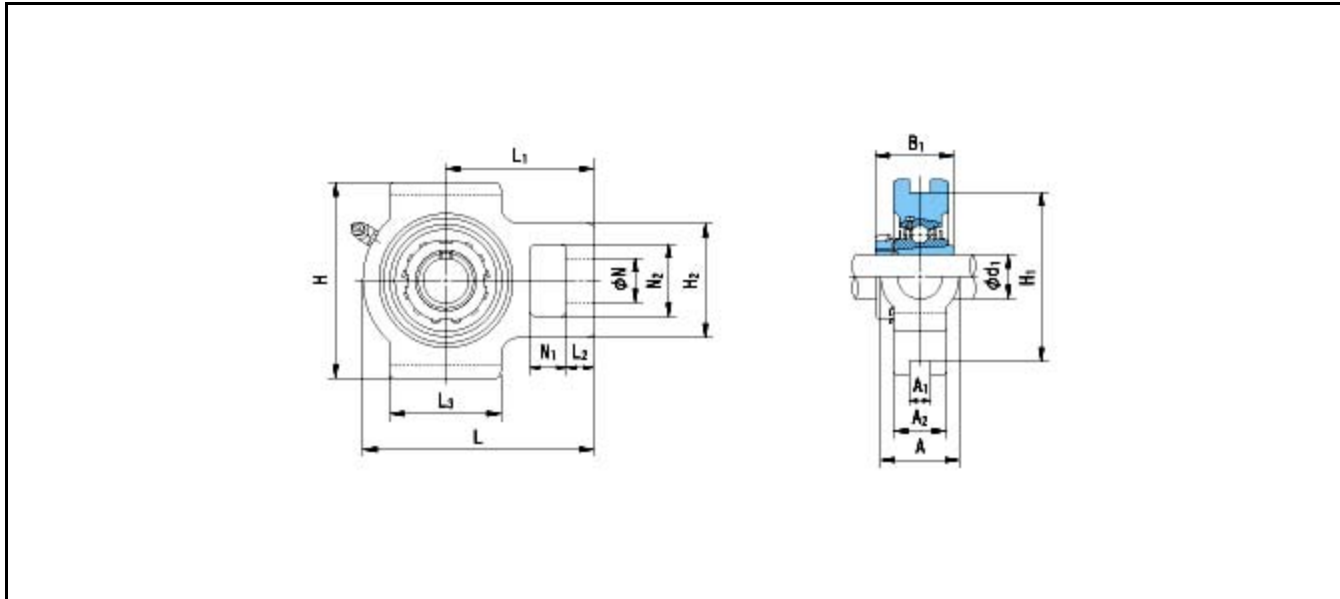

Dimensions

d1 = 50

A1 = 22

A2 = 44

A = 64

H1 = 130

B1 = 59

Mass = 5.1 kg

Basic Dynamic Load Rating Cr :	52500 N		INNER RING	OUTER RING
Basic Static Load Rating Cor :	36100 N	O.D.Surface Runout with Side :		-
Limiting Speed ;		Axial Runout with Bore :	-	-
Grease Lubrication :	- rpm	Axial Runout with Raceway :	-	-
Oil Lubrication :	- rpm	Width Variation :	-	-
		Radial Runout :	-	-