

ROECO

Bearing Data

Ball Bearing Units

Bearing No. : **UKT324+H2324**

Dimensions

- H = 355
- H2 = 210
- L = 432
- L1 = 267
- L2 = 42
- L3 = 230
- N = 70
- N1 = 60
- N2 = 140

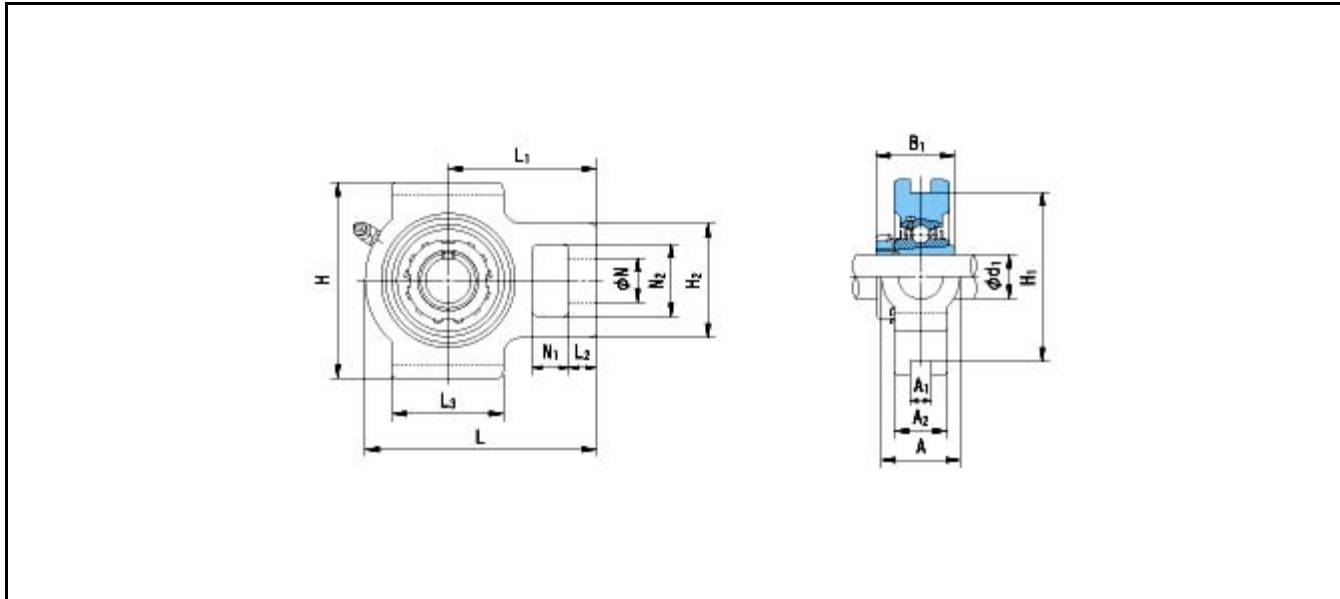

Dimensions

- d1 = 110
- A1 = 45
- A2 = 90
- A = 140
- H1 = 320
- B1 = 112
- Mass = 54.1 kg

Basic Dynamic Load Rating Cr :	207000 N	INNER RING	OUTER RING
Basic Static Load Rating Cor :	184800 N	O.D.Surface Runout with Side :	-
Limiting Speed ;		Axial Runout with Bore :	-
Grease Lubrication :	- rpm	Axial Runout with Raceway :	-
Oil Lubrication :	- rpm	Width Variation :	-
		Radial Runout :	-