

ROECO

Bearing Data

Ball Bearing Units

Bearing No. : **UKT320+H2320**

Dimensions

- H = 290
- H2 = 175
- L = 345
- L1 = 210
- L2 = 32
- L3 = 200
- N = 59
- N1 = 48
- N2 = 115

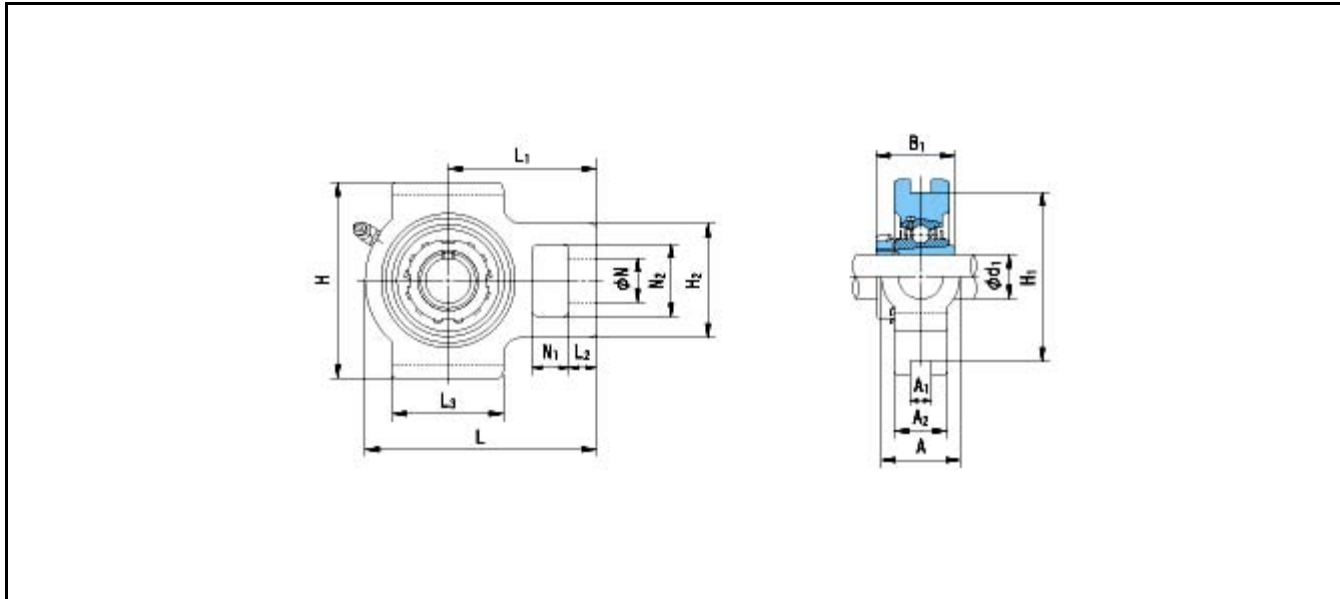

Dimensions

- d1 = 90
- A1 = 35
- A2 = 75
- A = 120
- H1 = 260
- B1 = 97
- Mass = 30.6 kg

Basic Dynamic Load Rating Cr :	173000 N	INNER RING	OUTER RING
Basic Static Load Rating Cor :	140400 N	O.D.Surface Runout with Side :	-
Limiting Speed ;		Axial Runout with Bore :	-
Grease Lubrication :	- rpm	Axial Runout with Raceway :	-
Oil Lubrication :	- rpm	Width Variation :	-
		Radial Runout :	-