

ROECO

# Bearing Data

## Ball Bearing Units

Bearing No. : **UKT319+H2319**

### Dimensions

- H = 270
- H2 = 165
- L = 322
- L1 = 197
- L2 = 31
- L3 = 180
- N = 57
- N1 = 46
- N2 = 106

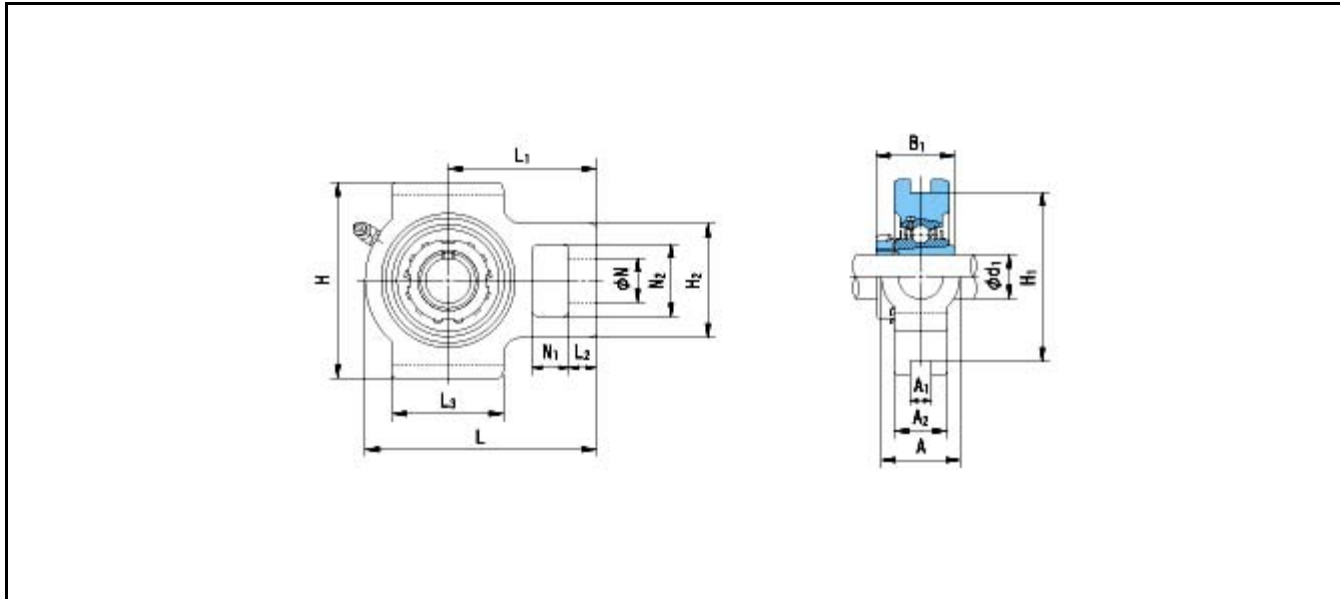

### Dimensions

- d1 = 85
- A1 = 35
- A2 = 72
- A = 110
- H1 = 240
- B1 = 90
- Mass = 24.4 kg

<b>Basic Dynamic Load Rating Cr :</b>	<b>153000 N</b>	<b>INNER RING</b>	<b>OUTER RING</b>
<b>Basic Static Load Rating Cor :</b>	<b>118400 N</b>	<b>O.D.Surface Runout with Side :</b>	-
<b>Limiting Speed ;</b>		<b>Axial Runout with Bore :</b>	-
<b>Grease Lubrication :</b>	- rpm	<b>Axial Runout with Raceway :</b>	-
<b>Oil Lubrication :</b>	- rpm	<b>Width Variation :</b>	-
		<b>Radial Runout :</b>	-