

ROECO

Bearing Data

Ball Bearing Units

Bearing No. : **UKT313+H2313**

Dimensions

H = 190

H2 = 116

L = 238

L1 = 146

L2 = 25

L3 = 134

N = 43

N1 = 32

N2 = 70

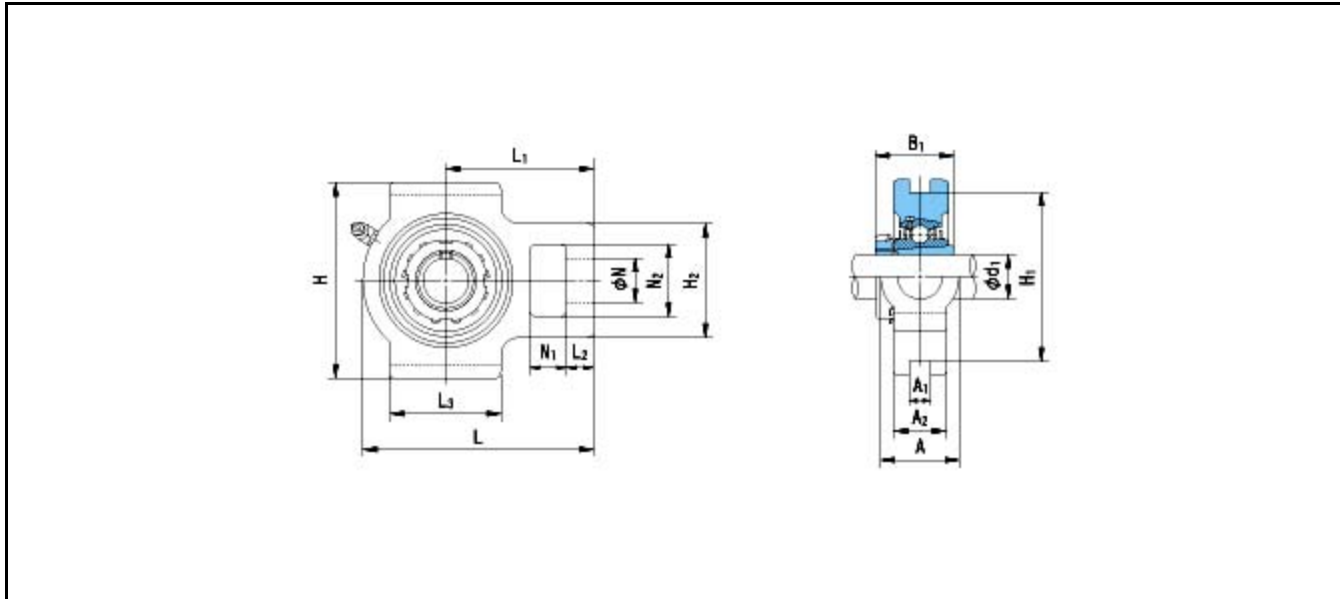

Dimensions

d1 = 60

A1 = 26

A2 = 50

A = 80

H1 = 170

B1 = 65

Mass = 9.1 kg

Basic Dynamic Load Rating Cr :	92500 N		INNER RING	OUTER RING
Basic Static Load Rating Cor :	59700 N	O.D.Surface Runout with Side :		-
Limiting Speed ;		Axial Runout with Bore :	-	-
Grease Lubrication :	- rpm	Axial Runout with Raceway :	-	-
Oil Lubrication :	- rpm	Width Variation :	-	-
		Radial Runout :	-	-