

ROECO

Bearing Data

Ball Bearing Units

Bearing No. : **UKT312+H2312**

Dimensions

H = 178

H2 = 113

L = 220

L1 = 135

L2 = 23

L3 = 123

N = 41

N1 = 31

N2 = 71

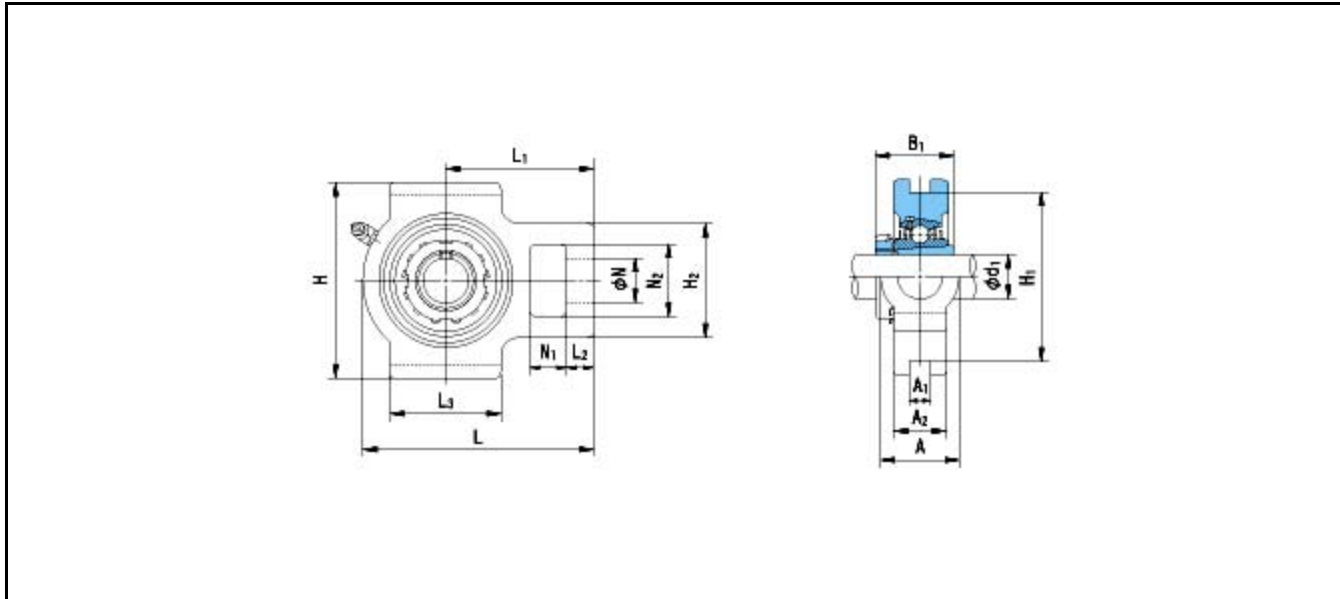

Dimensions

d1 = 55

A1 = 22

A2 = 46

A = 71

H1 = 160

B1 = 62

Mass = 7.6 kg

Basic Dynamic Load Rating Cr :	81500 N		INNER RING	OUTER RING
Basic Static Load Rating Cor :	52000 N	O.D.Surface Runout with Side :	-	-
Limiting Speed ;		Axial Runout with Bore :	-	-
Grease Lubrication :	- rpm	Axial Runout with Raceway :	-	-
Oil Lubrication :	- rpm	Width Variation :	-	-
		Radial Runout :	-	-