

ROECO

Bearing Data

Ball Bearing Units

Bearing No. : **UKT310+H2310**

Dimensions

H = 151

H2 = 98

L = 191

L1 = 117

L2 = 20

L3 = 106

N = 37

N1 = 27

N2 = 61

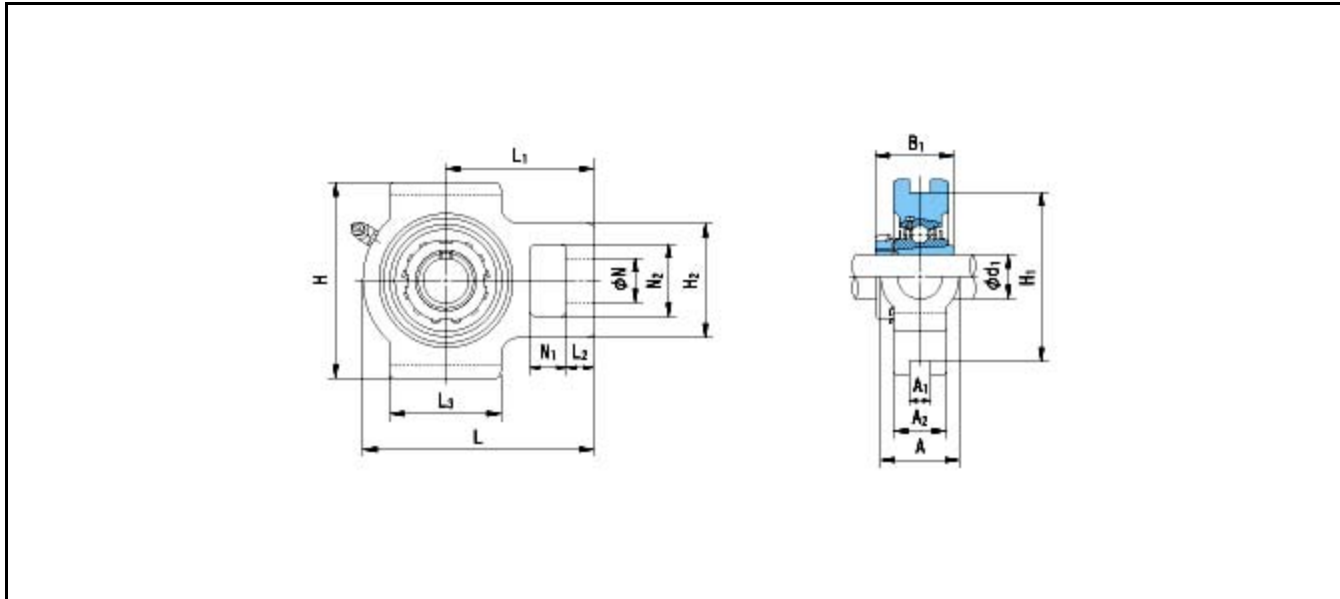

Dimensions

d1 = 45

A1 = 20

A2 = 40

A = 61

H1 = 140

B1 = 55

Mass = 5.3 kg

Basic Dynamic Load Rating Cr :	61500 N				
Basic Static Load Rating Cor :	38200 N	O.D.Surface Runout with Side :			-
Limiting Speed ;		Axial Runout with Bore :			-
Grease Lubrication :	- rpm	Axial Runout with Raceway :			-
Oil Lubrication :	- rpm	Width Variation :			-
		Radial Runout :			-