

ROECO

Bearing Data

Ball Bearing Units

Bearing No. : **UKT216+H2316**

Dimensions

H = 184

H2 = 111

L = 235

L1 = 140

L2 = 21

L3 = 121

N = 41

N1 = 32

N2 = 70

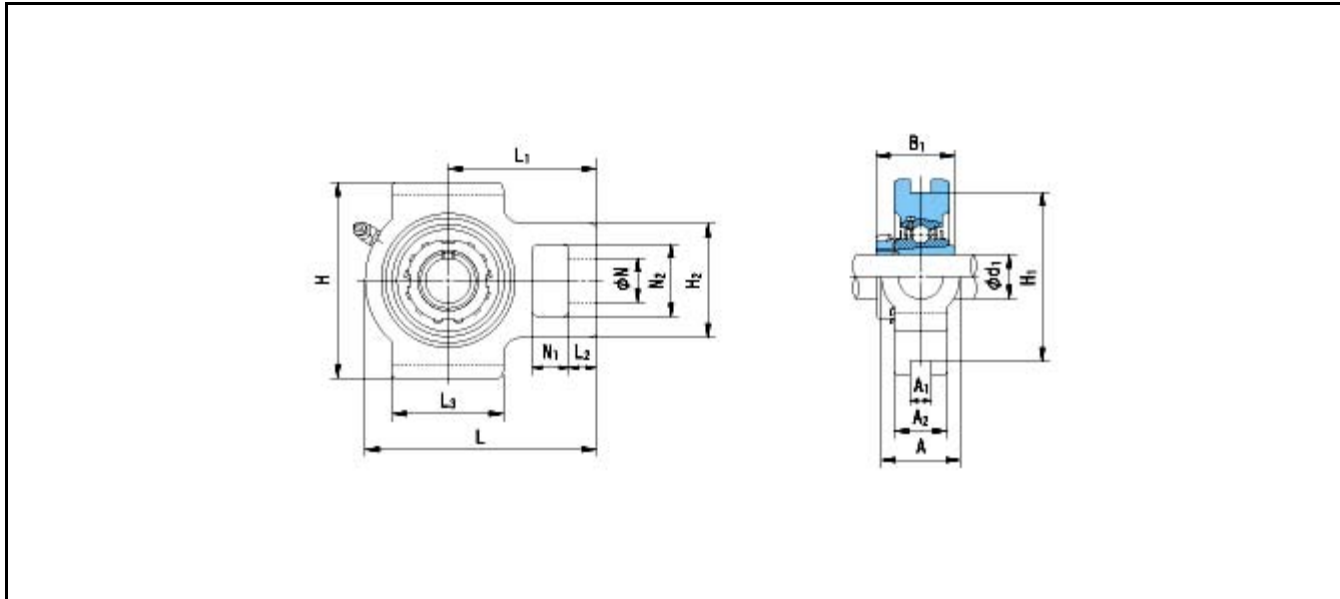

Dimensions

d1 = 70

A1 = 26

A2 = 51

A = 70

H1 = 165

B1 = 78

Mass = 8.9 kg

Basic Dynamic Load Rating Cr :	72500 N	INNER RING	OUTER RING
Basic Static Load Rating Cor :	53000 N	O.D.Surface Runout with Side :	-
Limiting Speed ;		Axial Runout with Bore :	-
Grease Lubrication :	- rpm	Axial Runout with Raceway :	-
Oil Lubrication :	- rpm	Width Variation :	-
		Radial Runout :	-