

ROECO

Bearing Data

Ball Bearing Units

Bearing No. : **UKT208+H2308**

Dimensions

- H = 114
- H2 = 83
- L = 144
- L1 = 88
- L2 = 16
- L3 = 83
- N = 29
- N1 = 19
- N2 = 49

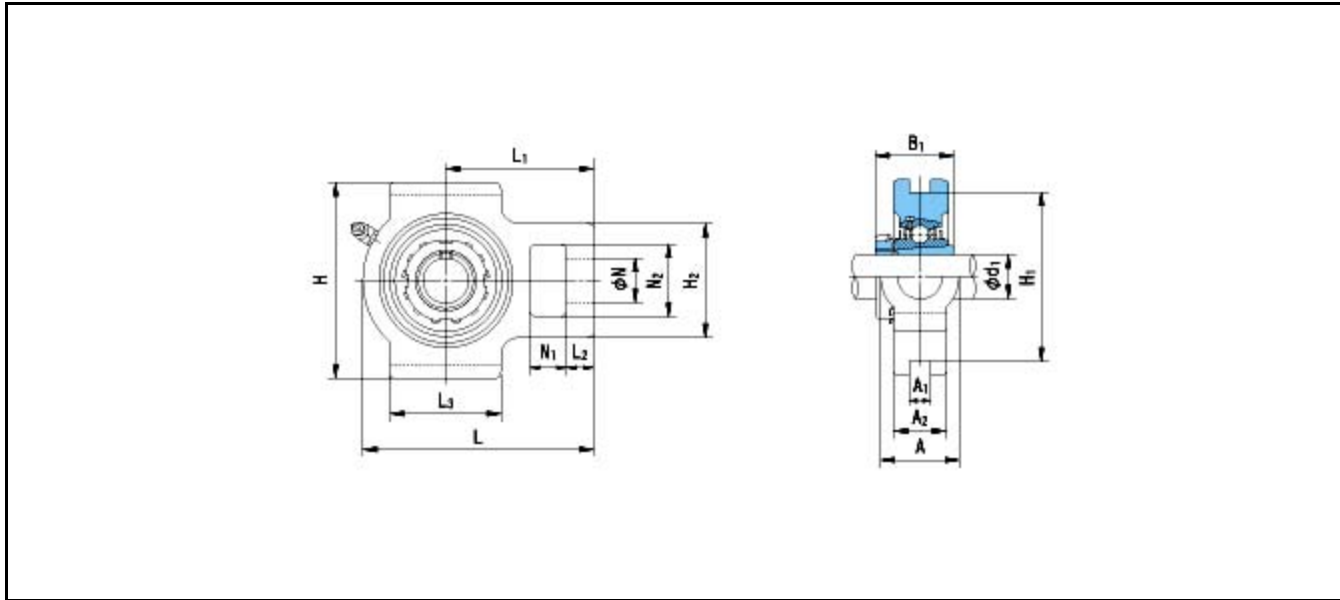

Dimensions

- d1 = 35
- A1 = 16
- A2 = 33
- A = 49
- H1 = 102
- B1 = 46
- Mass = 2.5 kg

Basic Dynamic Load Rating Cr :	29300 N	INNER RING	OUTER RING
Basic Static Load Rating Cor :	17900 N	O.D.Surface Runout with Side :	-
Limiting Speed ;		Axial Runout with Bore :	-
Grease Lubrication :	- rpm	Axial Runout with Raceway :	-
Oil Lubrication :	- rpm	Width Variation :	-
		Radial Runout :	-