

ROECO

Bearing Data

Ball Bearing Units

Bearing No. : **UKT206+H2306**

Dimensions

H = 102

H2 = 56

L = 113

L1 = 70

L2 = 10

L3 = 57

N = 22

N1 = 16

N2 = 37

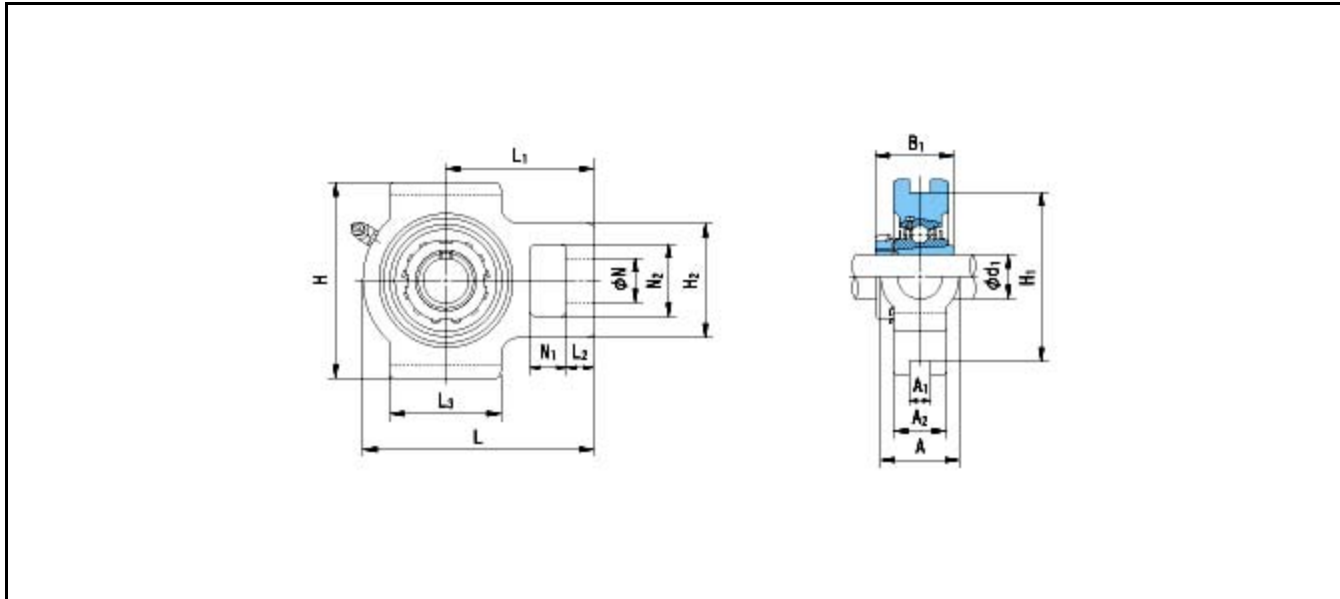

Dimensions

d1 = 25

A1 = 12

A2 = 28

A = 37

H1 = 89

B1 = 38

Mass = 1.4 kg

Basic Dynamic Load Rating Cr :	19600 N				
Basic Static Load Rating Cor :	11300 N	O.D.Surface Runout with Side :			-
Limiting Speed ;		Axial Runout with Bore :			-
Grease Lubrication :	- rpm	Axial Runout with Raceway :			-
Oil Lubrication :	- rpm	Width Variation :			-
		Radial Runout :			-