

ROECO

Bearing Data

Ball Bearing Units

Bearing No. : **UKPX13+H2313**

Dimensions

H = 76.2

L = 286

J = 203

N1 = 41

H1 = 32

H2 = 154

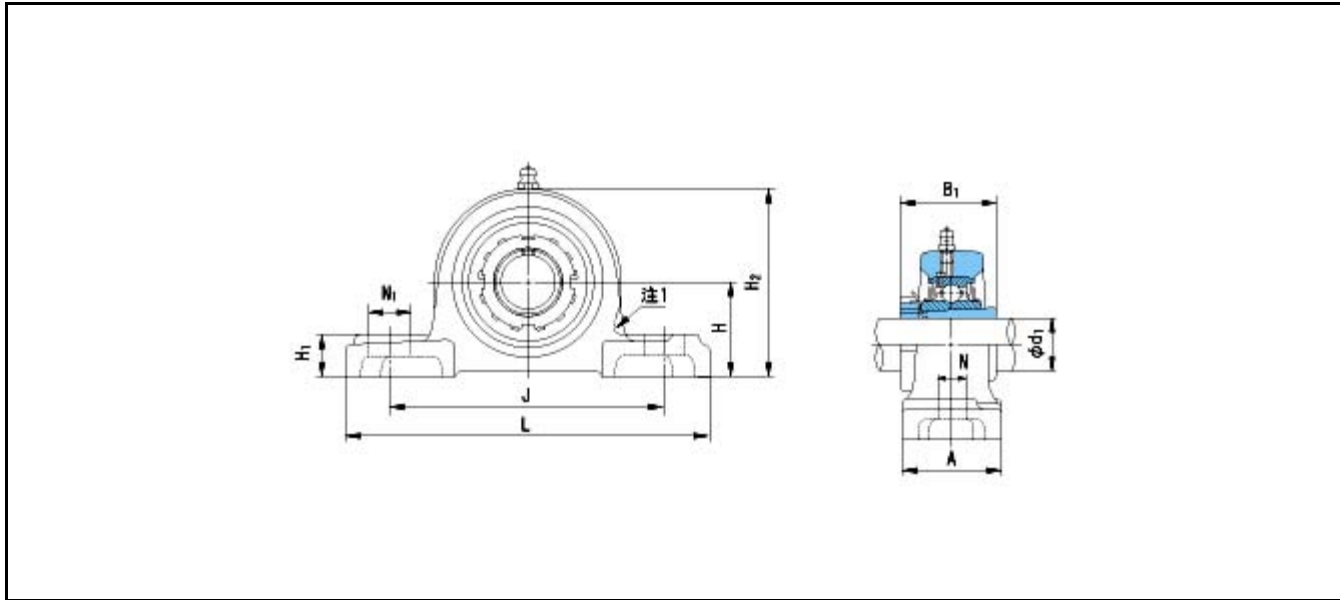

Dimensions

d1 = 60

A = 83

N = 25

B1 = 65

Mass = 7.2 kg

Basic Dynamic Load Rating Cr :	62000 N		INNER RING	OUTER RING
Basic Static Load Rating Cor :	44000 N	O.D.Surface Runout with Side :		-
Limiting Speed ;		Axial Runout with Bore :	-	-
Grease Lubrication :	- rpm	Axial Runout with Raceway :	-	-
Oil Lubrication :	- rpm	Width Variation :	-	-
		Radial Runout :	-	-