

ROECO

Bearing Data

Ball Bearing Units

Bearing No. : **UKPX09C+H2309**

Dimensions

H = 58.7

L = 222

J = 156

N1 = 33

H1 = 26

H2 = 116

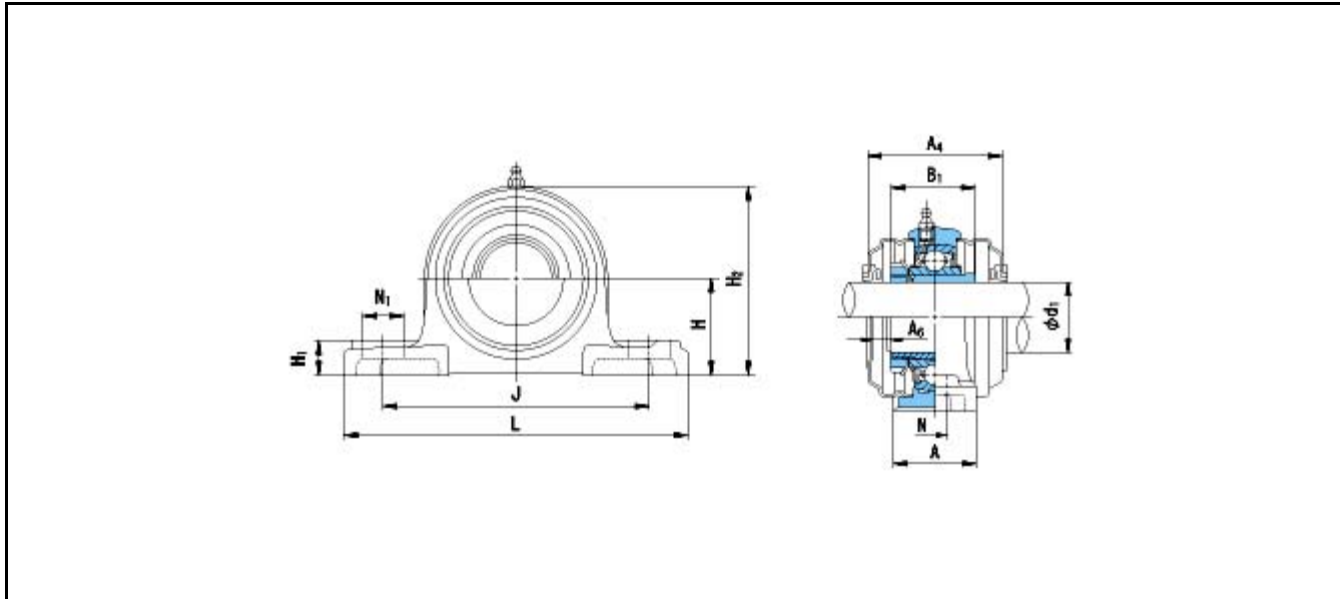

Dimensions

d1 = 40

A = 67

N = 20

B1 = 50

A4 = 87

A6 = 16

Mass = 3.6 kg

Basic Dynamic Load Rating Cr :	35500 N		INNER RING	OUTER RING
Basic Static Load Rating Cor :	23200 N	O.D.Surface Runout with Side :		-
Limiting Speed ;		Axial Runout with Bore :	-	-
Grease Lubrication :	- rpm	Axial Runout with Raceway :	-	-
Oil Lubrication :	- rpm	Width Variation :	-	-
		Radial Runout :	-	-