

ROECO

# Bearing Data

## Ball Bearing Units

Bearing No. : **UKPX05+H2305**

Dimensions

H = 44.4

L = 159

J = 119

N1 = 25

H1 = 18

H2 = 85

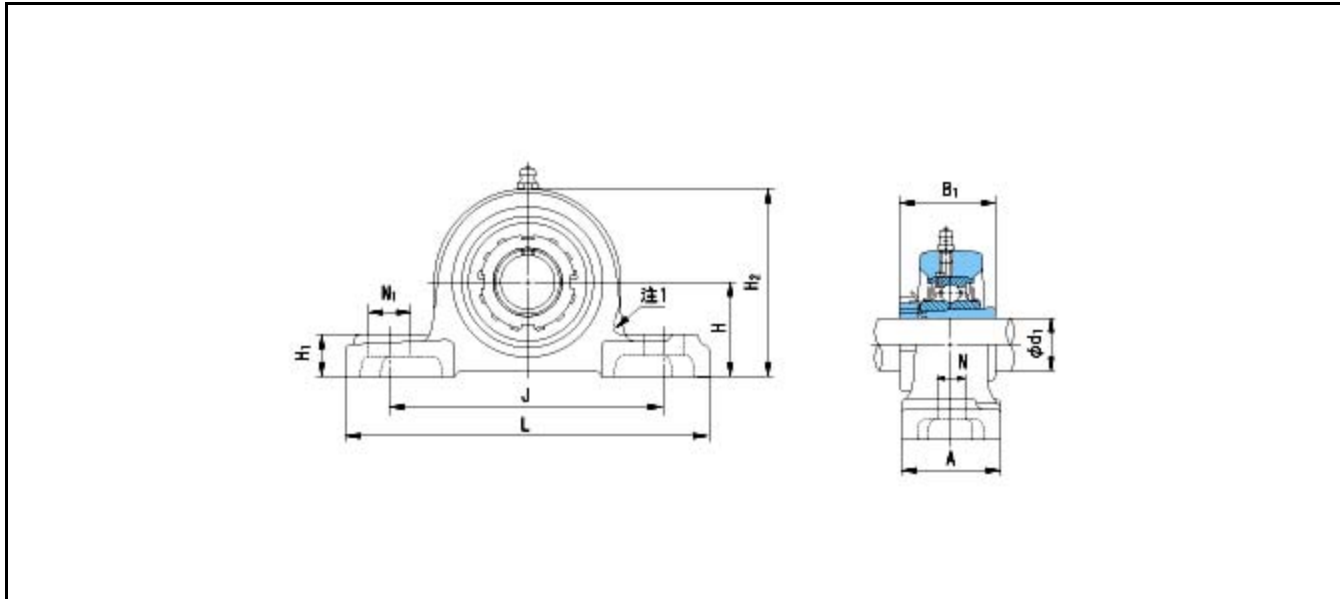

Dimensions

d1 = 20

A = 51

N = 17

B1 = 35

Mass = 1.5 kg

Basic Dynamic Load Rating Cr :	<b>19600 N</b>	INNER RING	OUTER RING
Basic Static Load Rating Cor :	<b>11300 N</b>	O.D.Surface Runout with Side :	-
Limiting Speed ;		Axial Runout with Bore :	-
Grease Lubrication :	- rpm	Axial Runout with Raceway :	-
Oil Lubrication :	- rpm	Width Variation :	-
		Radial Runout :	-