

ROECO

# Bearing Data

## Ball Bearing Units

Bearing No. : **UKP320+H2320**

Dimensions

H = 140

L = 490

J = 380

N1 = 50

H1 = 55

H2 = 275

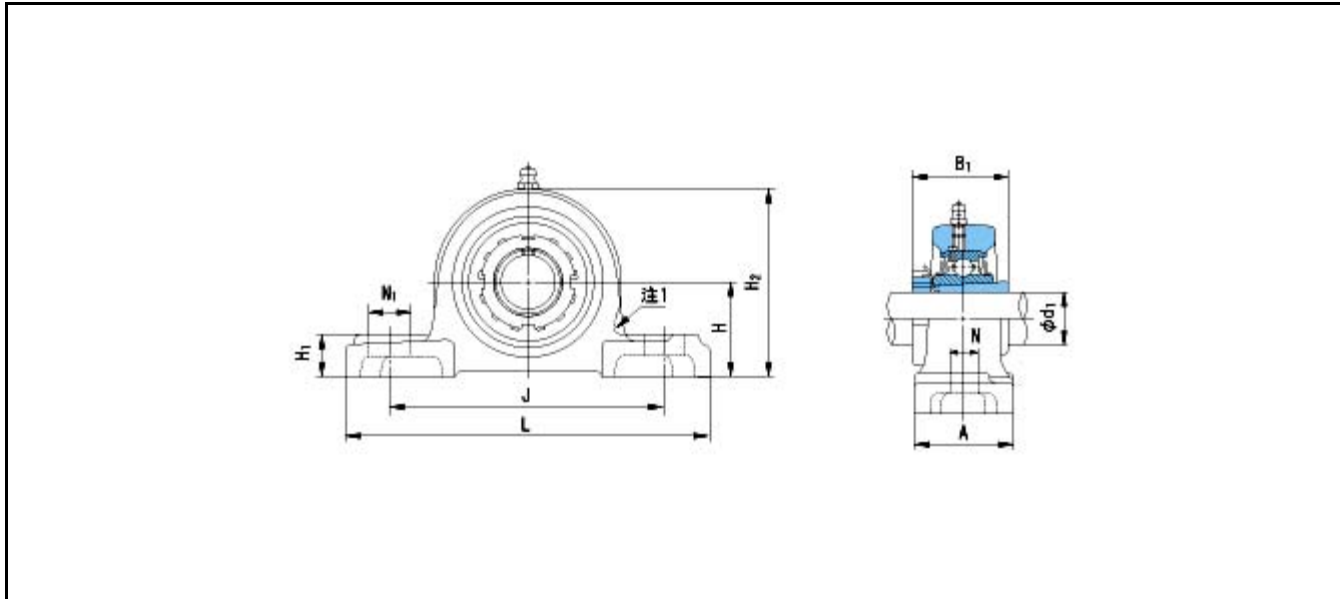

Dimensions

d1 = 90

A = 120

N = 36

B1 = 97

Mass = 34.3 kg

Basic Dynamic Load Rating Cr :	<b>173000 N</b>	INNER RING	OUTER RING
Basic Static Load Rating Cor :	<b>140400 N</b>	O.D.Surface Runout with Side :	-
Limiting Speed ;		Axial Runout with Bore :	-
Grease Lubrication :	- rpm	Axial Runout with Raceway :	-
Oil Lubrication :	- rpm	Width Variation :	-
		Radial Runout :	-