

ROECO

Bearing Data

Ball Bearing Units

Bearing No. : **UKP318+H2318**

Dimensions

H = 118

L = 430

J = 330

N1 = 45

H1 = 50

H2 = 233

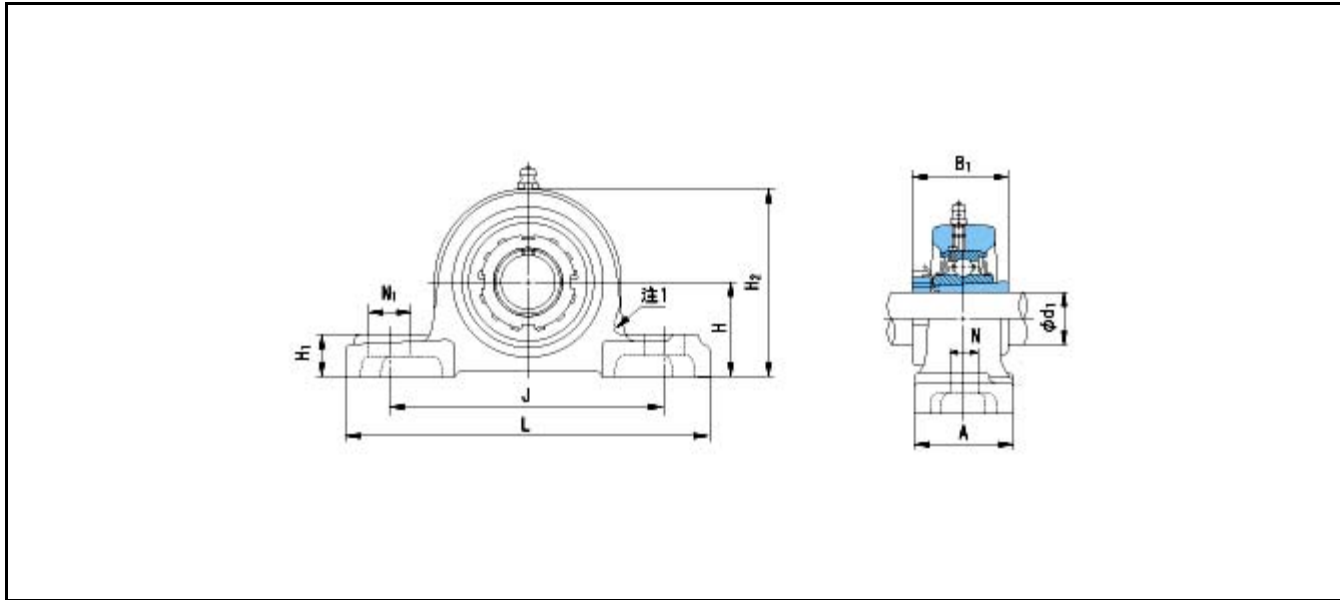

Dimensions

d1 = 80

A = 110

N = 33

B1 = 86

Mass = 21.1 kg

Basic Dynamic Load Rating Cr :	143000 N	INNER RING	OUTER RING
Basic Static Load Rating Cor :	107200 N	O.D.Surface Runout with Side :	-
Limiting Speed ;		Axial Runout with Bore :	-
Grease Lubrication :	- rpm	Axial Runout with Raceway :	-
Oil Lubrication :	- rpm	Width Variation :	-
		Radial Runout :	-