

ROECO

Bearing Data

Ball Bearing Units

Bearing No. : **UKP312+H2312**

Dimensions

- H = 85
- L = 330
- J = 250
- N1 = 38
- H1 = 33
- H2 = 165

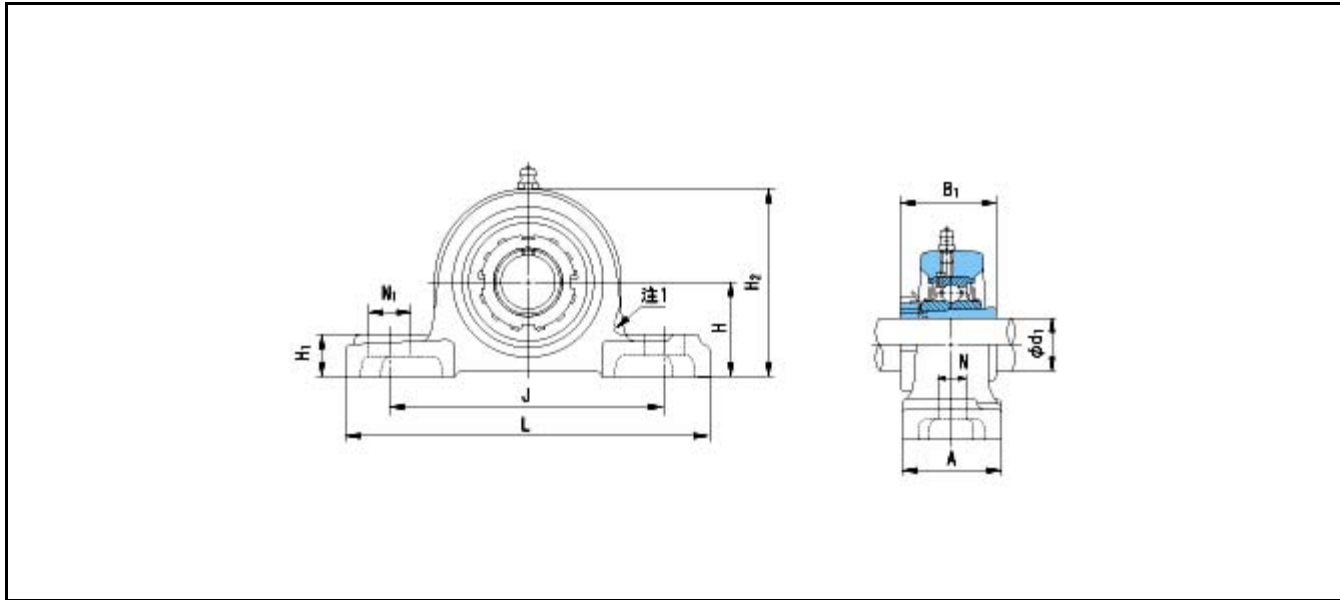

Dimensions

- d1 = 55
- A = 85
- N = 25
- B1 = 62
- Mass = 9.3 kg

Basic Dynamic Load Rating Cr :	81500 N		INNER RING	OUTER RING
Basic Static Load Rating Cor :	52000 N	O.D.Surface Runout with Side :		-
Limiting Speed ;		Axial Runout with Bore :	-	-
Grease Lubrication :	- rpm	Axial Runout with Raceway :	-	-
Oil Lubrication :	- rpm	Width Variation :	-	-
		Radial Runout :	-	-