

ROECO

Bearing Data

Ball Bearing Units

Bearing No. : **UKP310+H2310**

Dimensions

- H = 75
- L = 275
- J = 212
- N1 = 35
- H1 = 28
- H2 = 143

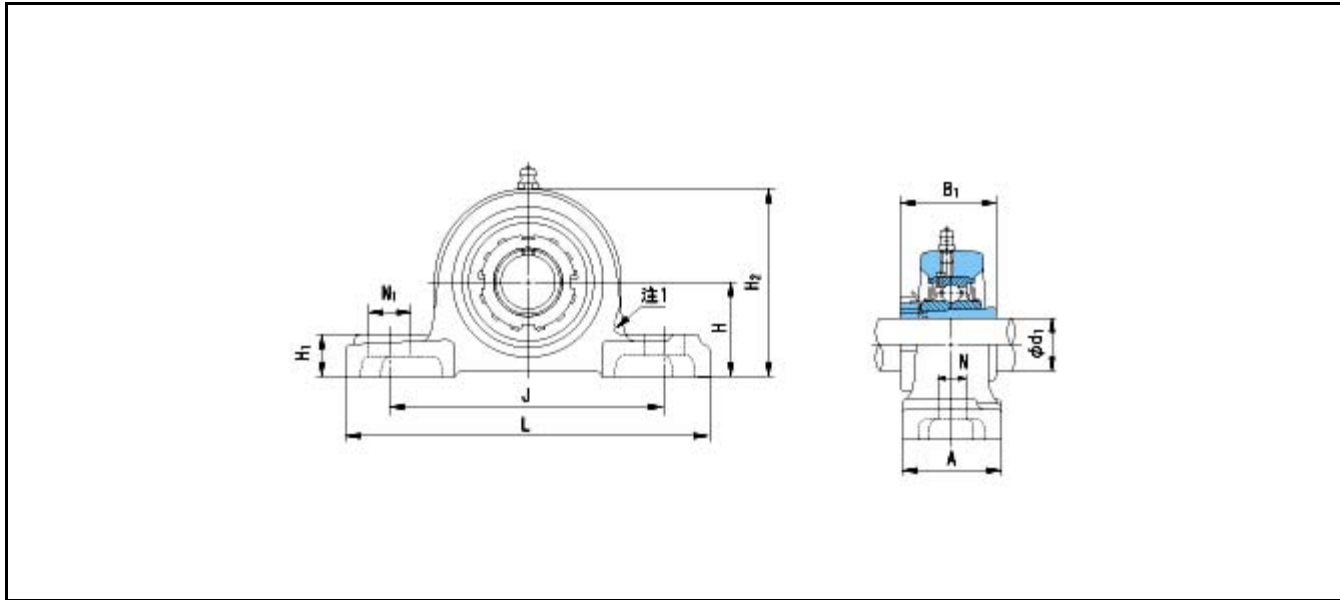

Dimensions

- d1 = 45
- A = 75
- N = 20
- B1 = 55
- Mass = 6.2 kg

Basic Dynamic Load Rating Cr :	61500 N		INNER RING	OUTER RING
Basic Static Load Rating Cor :	38200 N	O.D.Surface Runout with Side :		-
Limiting Speed ;		Axial Runout with Bore :	-	-
Grease Lubrication :	- rpm	Axial Runout with Raceway :	-	-
Oil Lubrication :	- rpm	Width Variation :	-	-
		Radial Runout :	-	-