

ROECO

Bearing Data

Ball Bearing Units

Bearing No. : **UKP213E+H2313**

Dimensions

- H = 76.2
- L = 265
- J = 203
- N1 = 29
- H1 = 27
- H2 = 150

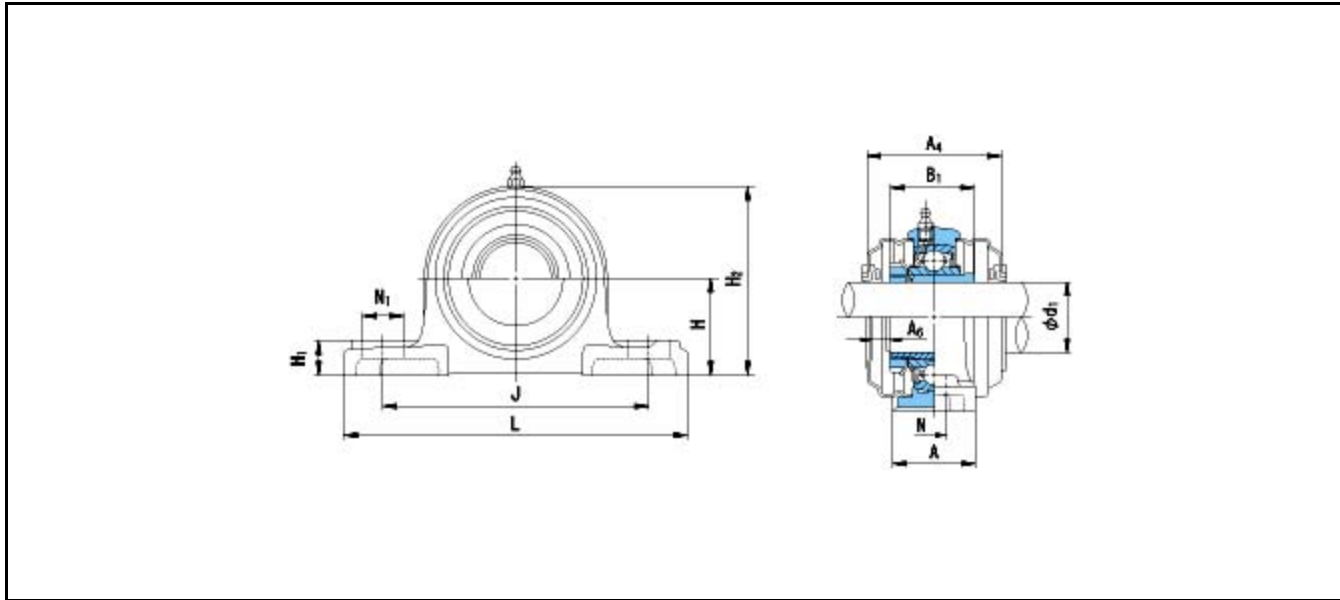

Dimensions

- d1 = 60
- A = 70
- N = 25
- B1 = 65
- A4 = 102
- A6 = 17
- Mass = 6.2 kg

Basic Dynamic Load Rating Cr :	57500 N			
Basic Static Load Rating Cor :	40000 N	O.D.Surface Runout with Side :		-
Limiting Speed ;		Axial Runout with Bore :		-
Grease Lubrication :	- rpm	Axial Runout with Raceway :		-
Oil Lubrication :	- rpm	Width Variation :		-
		Radial Runout :		-