

ROECO

Bearing Data

Ball Bearing Units

Bearing No. : **UKP213+H2313**

Dimensions

H = 76.2

L = 265

J = 203

N1 = 29

H1 = 27

H2 = 150

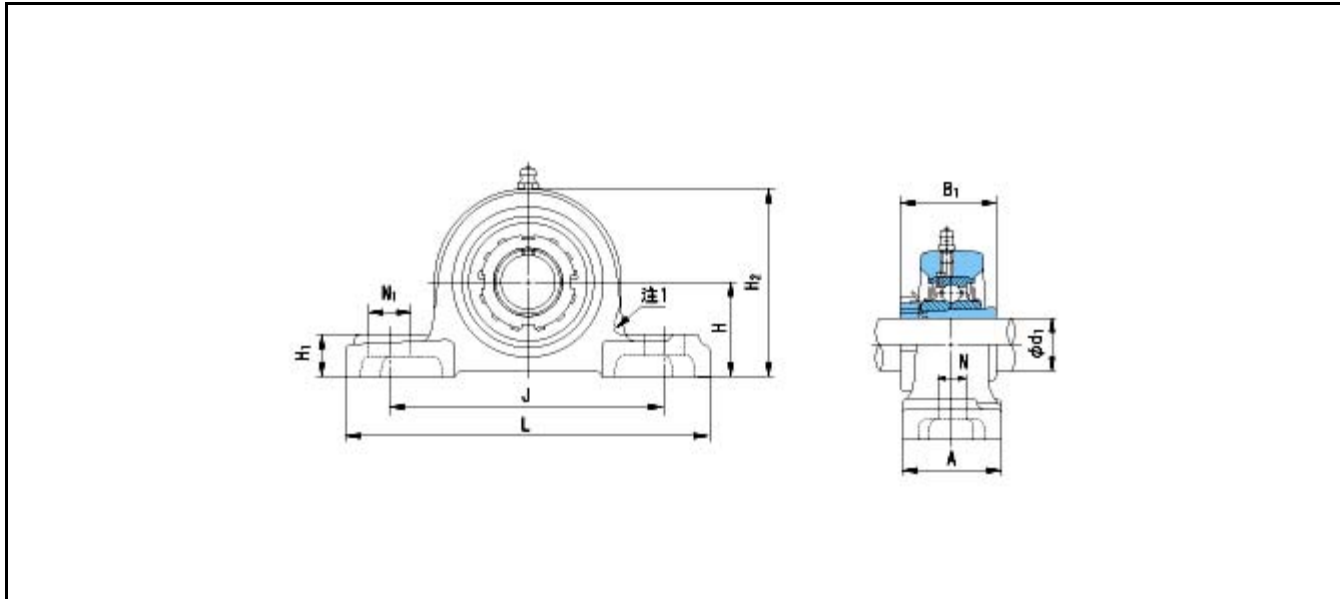

Dimensions

d1 = 60

A = 70

N = 25

B1 = 65

Mass = 5.7 kg

Basic Dynamic Load Rating Cr :	57500 N	INNER RING	OUTER RING
Basic Static Load Rating Cor :	40000 N	O.D.Surface Runout with Side :	-
Limiting Speed ;		Axial Runout with Bore :	-
Grease Lubrication :	- rpm	Axial Runout with Raceway :	-
Oil Lubrication :	- rpm	Width Variation :	-
		Radial Runout :	-