

ROECO

Bearing Data

Ball Bearing Units

Bearing No. : **UKP211E+H2311**

Dimensions

- H = 63.5
- L = 219
- J = 171
- N1 = 25
- H1 = 22
- H2 = 126

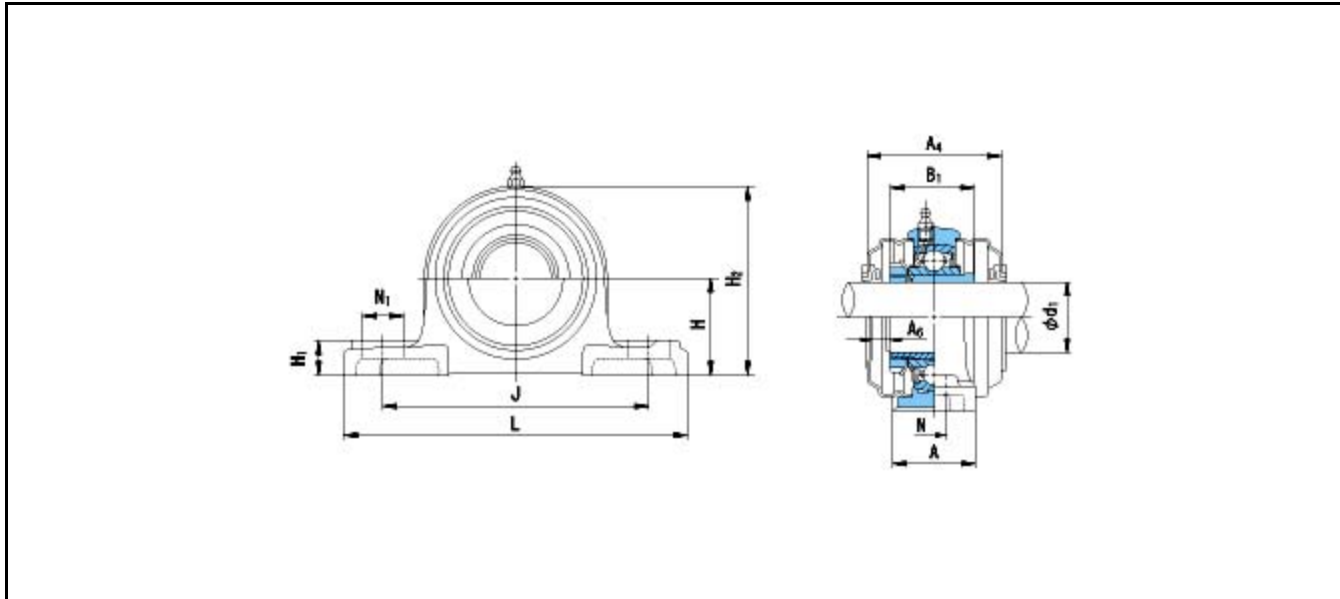

Dimensions

- d1 = 50
- A = 60
- N = 20
- B1 = 59
- A4 = 88
- A6 = 14
- Mass = 3.8 kg

Basic Dynamic Load Rating Cr :	43000 N			
Basic Static Load Rating Cor :	29400 N	O.D.Surface Runout with Side :		-
Limiting Speed ;		Axial Runout with Bore :		-
Grease Lubrication :	- rpm	Axial Runout with Raceway :		-
Oil Lubrication :	- rpm	Width Variation :		-
		Radial Runout :		-