

ROECO

Bearing Data

Ball Bearing Units

Bearing No. : **UKP210C+H2310**

Dimensions

H = 57.2

L = 206

J = 159

N1 = 25

H1 = 22

H2 = 114

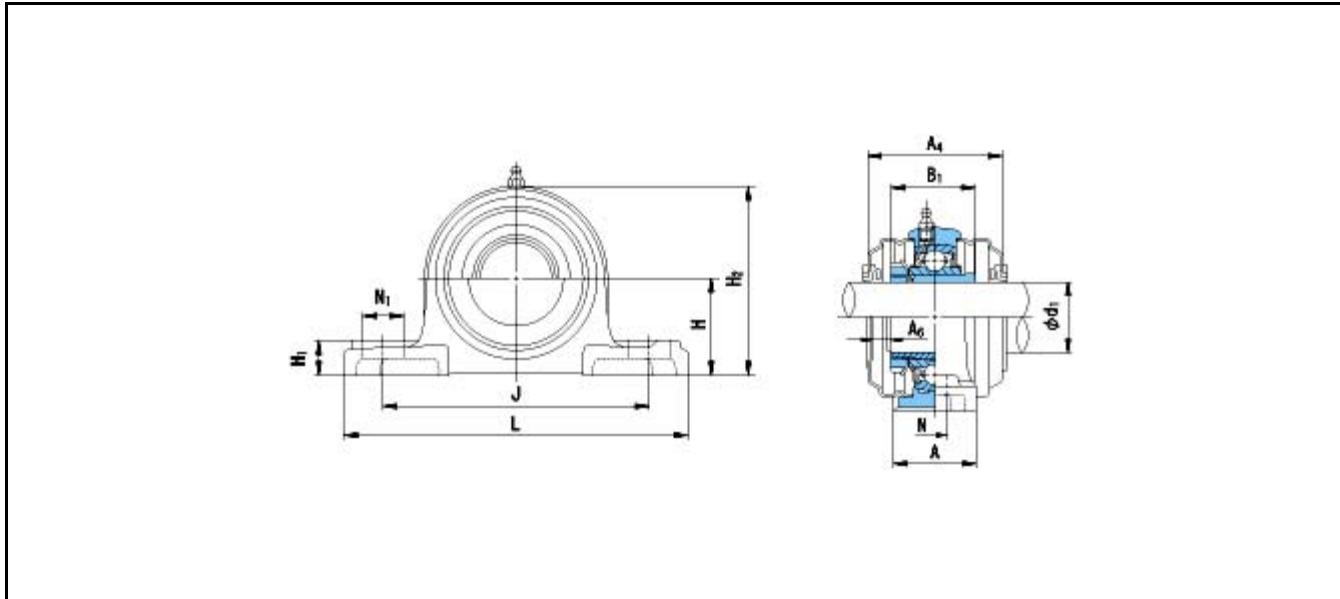

Dimensions

d1 = 45

A = 60

N = 20

B1 = 55

A4 = 87

A6 = 15

Mass = 3.2 kg

Basic Dynamic Load Rating Cr :	35500 N		
Basic Static Load Rating Cor :	23200 N	O.D.Surface Runout with Side :	-
Limiting Speed ;		Axial Runout with Bore :	-
Grease Lubrication :	- rpm	Axial Runout with Raceway :	-
Oil Lubrication :	- rpm	Width Variation :	-
		Radial Runout :	-