

ROECO

Bearing Data

Ball Bearing Units

Bearing No. : **UKP208+H2308**

Dimensions

H = 49.2

L = 184

J = 137

N1 = 25

H1 = 19

H2 = 100

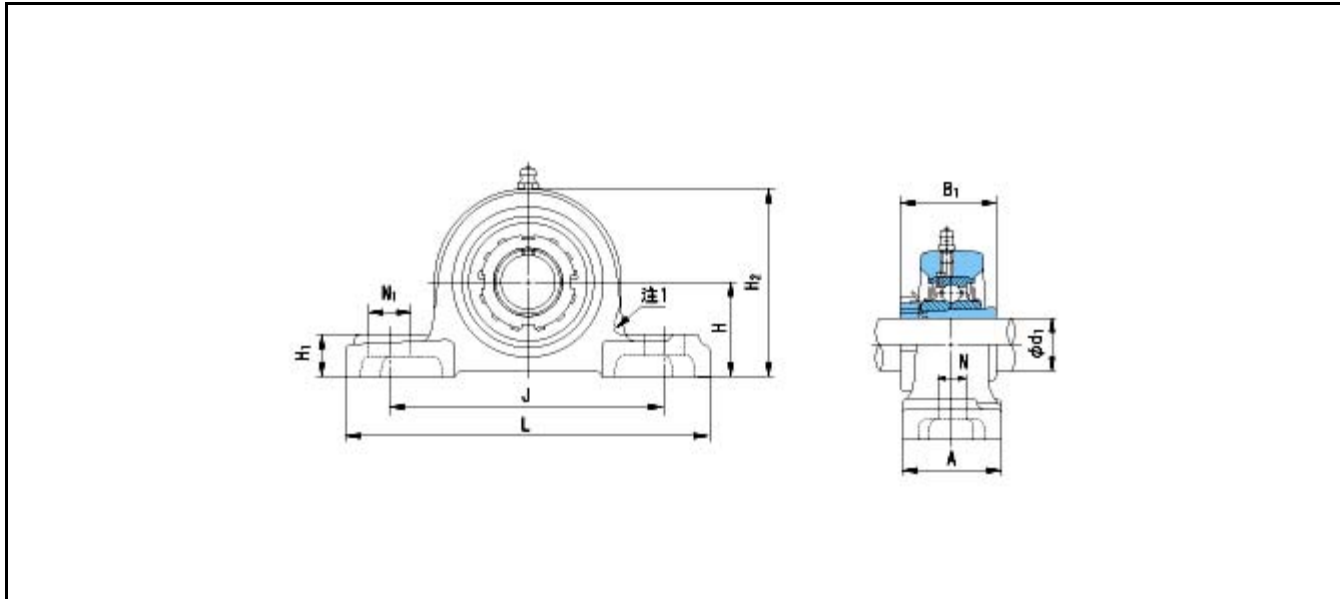

Dimensions

d1 = 35

A = 54

N = 17

B1 = 46

Mass = 2.1 kg

Basic Dynamic Load Rating Cr :	29300 N	INNER RING	OUTER RING
Basic Static Load Rating Cor :	17900 N	O.D.Surface Runout with Side :	-
Limiting Speed ;		Axial Runout with Bore :	-
Grease Lubrication :	- rpm	Axial Runout with Raceway :	-
Oil Lubrication :	- rpm	Width Variation :	-
		Radial Runout :	-