

ROECO

Bearing Data

Ball Bearing Units

Bearing No. : **UKP207+H2307**

Dimensions

H = 47.6

L = 167

J = 127

N1 = 21

H1 = 19

H2 = 94

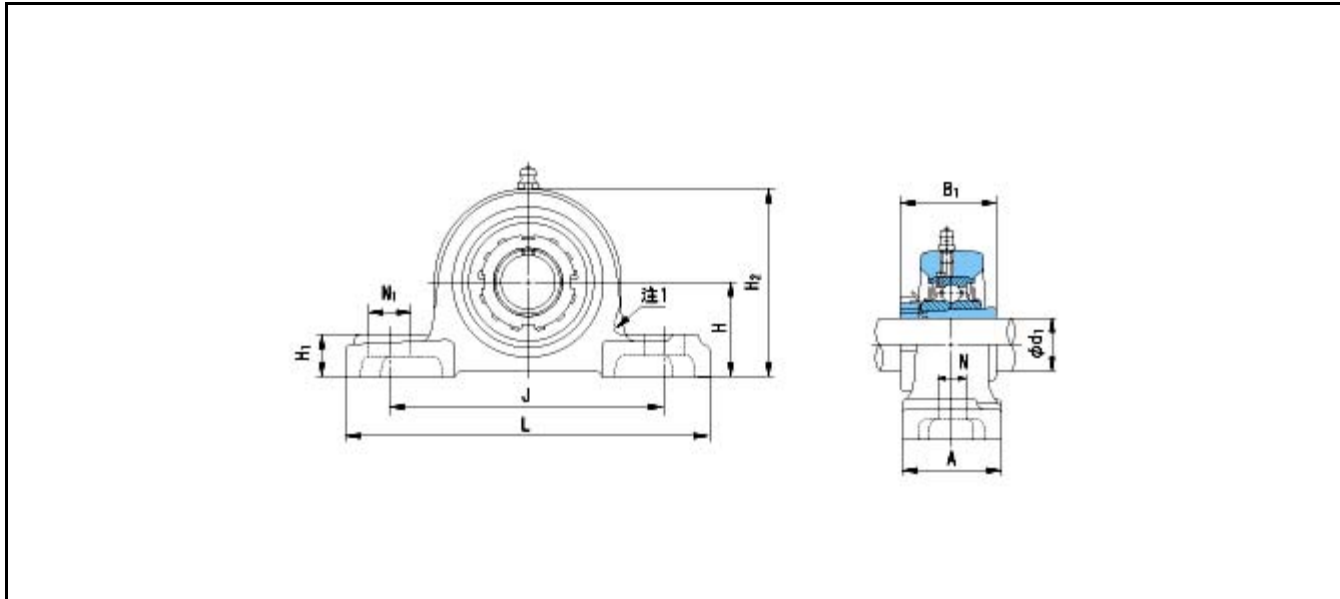

Dimensions

d1 = 30

A = 48

N = 17

B1 = 43

Mass = 1.6 kg

Basic Dynamic Load Rating Cr :	25900 N		INNER RING	OUTER RING
Basic Static Load Rating Cor :	15400 N	O.D.Surface Runout with Side :		-
Limiting Speed ;		Axial Runout with Bore :	-	-
Grease Lubrication :	- rpm	Axial Runout with Raceway :	-	-
Oil Lubrication :	- rpm	Width Variation :	-	-
		Radial Runout :	-	-