

ROECO

Bearing Data

Ball Bearing Units

Bearing No. : **UKFX10+H2310**

Dimensions

L = 162

J = 130

N = 19

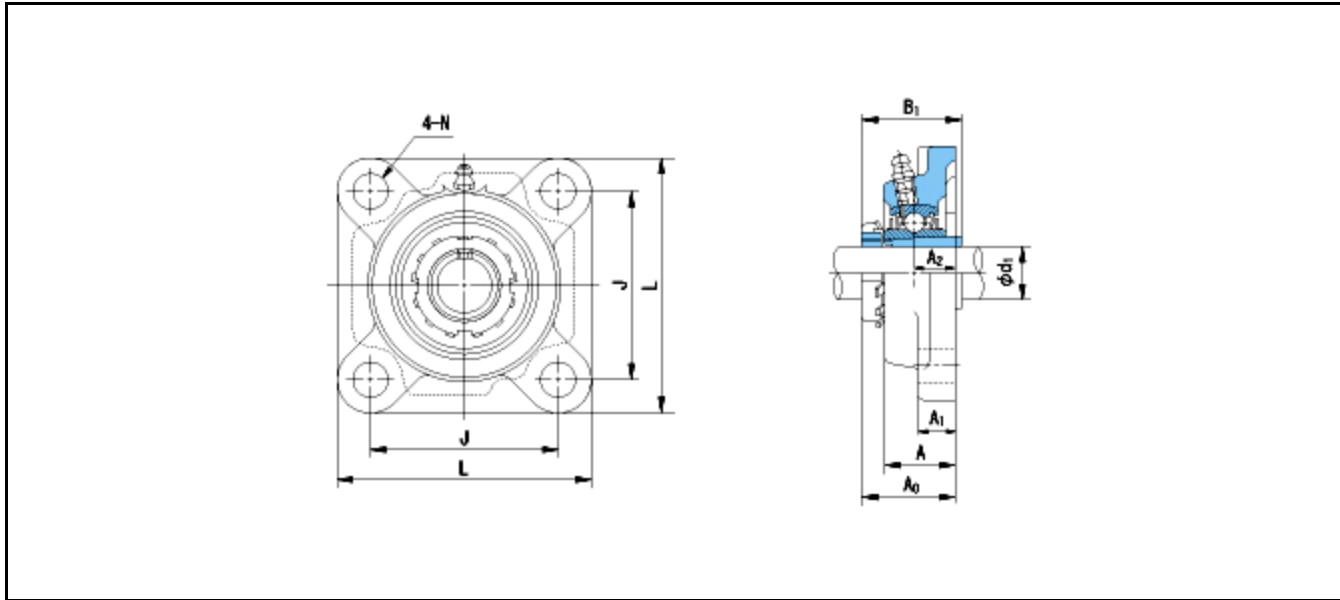

Dimensions

d1 = 45

A1 = 20

A2 = 26

B1 = 55

A = 44

A0 = 54.5

Mass = 3.6 kg

Basic Dynamic Load Rating Cr :	43000 N			
Basic Static Load Rating Cor :	29400 N	O.D.Surface Runout with Side :		-
Limiting Speed ;		Axial Runout with Bore :	-	
Grease Lubrication :	- rpm	Axial Runout with Raceway :	-	-
Oil Lubrication :	- rpm	Width Variation :	-	-
		Radial Runout :	-	-