

ROECO

Bearing Data

Ball Bearing Units

Bearing No. : **UKFX07C+H2307**

Dimensions

L = 130

J = 102

N = 16

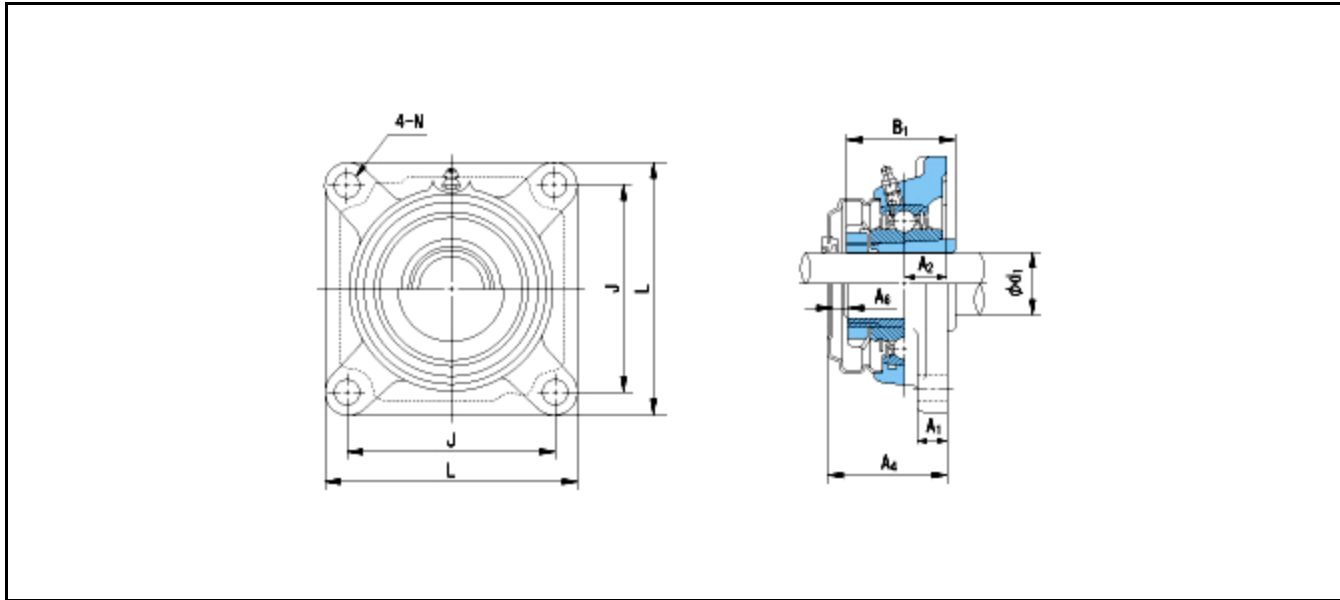

Dimensions

d1 = 30

A1 = 14

A2 = 21

B1 = 43

A4 = 63

A6 = 17

Mass = 1.8 kg

Basic Dynamic Load Rating Cr :	29300 N		
Basic Static Load Rating Cor :	17900 N	O.D.Surface Runout with Side :	-
Limiting Speed ;		Axial Runout with Bore :	-
Grease Lubrication :	- rpm	Axial Runout with Raceway :	-
Oil Lubrication :	- rpm	Width Variation :	-
		Radial Runout :	-