

ROECO

Bearing Data

Ball Bearing Units

Bearing No. : **UKFX06+H2306**

Dimensions

L = 117

J = 92

N = 16

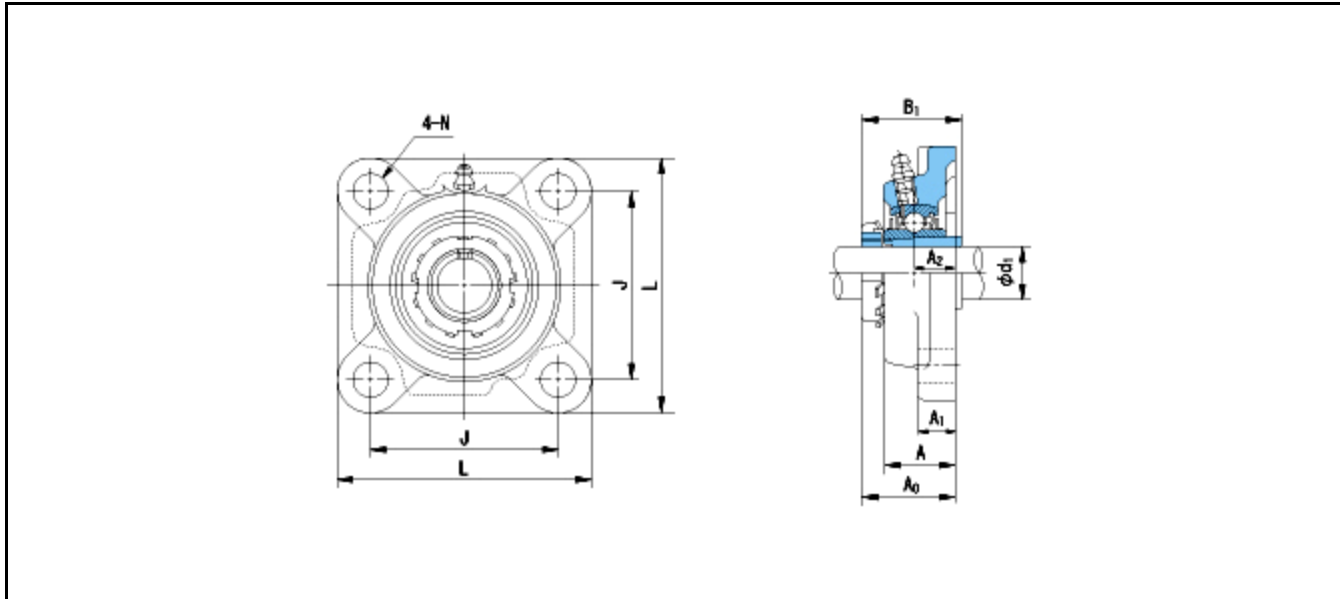

Dimensions

d1 = 25

A1 = 14

A2 = 19

B1 = 38

A = 34

A0 = 40.5

Mass = 1.4 kg

Basic Dynamic Load Rating Cr :	25900 N			
Basic Static Load Rating Cor :	15400 N	O.D.Surface Runout with Side :		-
Limiting Speed ;		Axial Runout with Bore :	-	
Grease Lubrication :	- rpm	Axial Runout with Raceway :	-	-
Oil Lubrication :	- rpm	Width Variation :	-	-
		Radial Runout :	-	-