

ROECO

Bearing Data

Ball Bearing Units

Bearing No. : **UKFX05E+H2305**

Dimensions

L = 108

J = 83

N = 12

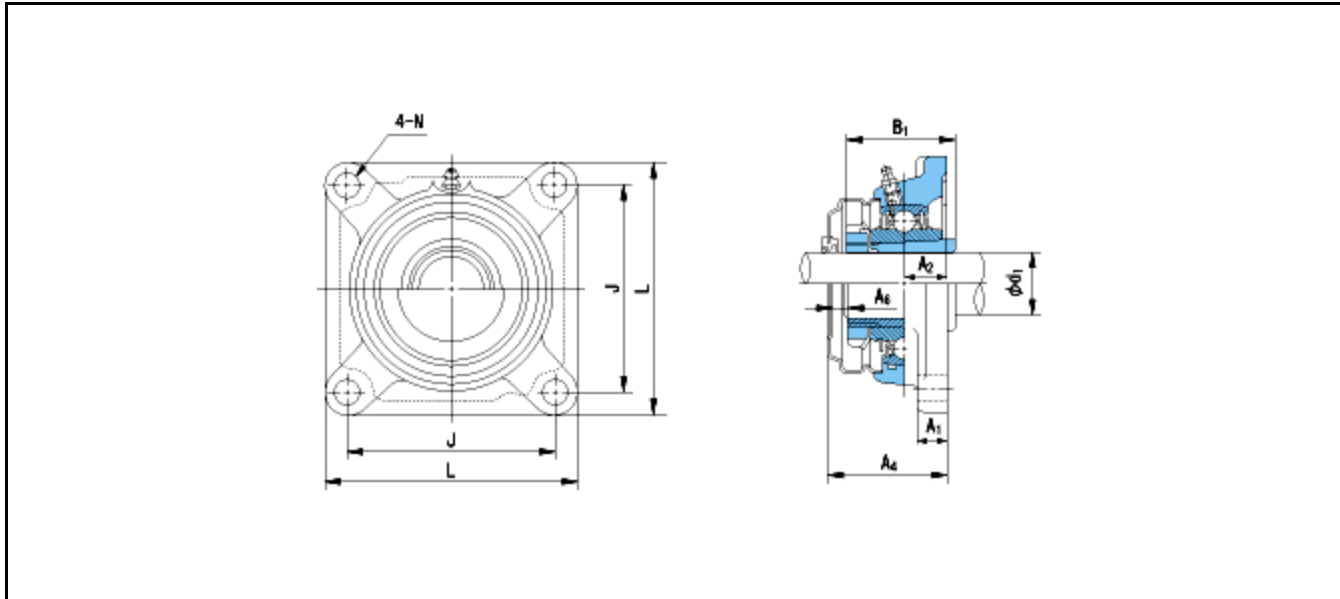

Dimensions

d1 = 20

A1 = 13

A2 = 18

B1 = 35

A4 = 51

A6 = 10

Mass = 1.2 kg

Basic Dynamic Load Rating Cr :	19600 N		
Basic Static Load Rating Cor :	11300 N	O.D.Surface Runout with Side :	-
Limiting Speed ;		Axial Runout with Bore :	-
Grease Lubrication :	- rpm	Axial Runout with Raceway :	-
Oil Lubrication :	- rpm	Width Variation :	-
		Radial Runout :	-