

ROECO

Bearing Data

Ball Bearing Units

Bearing No. : **UKFS313+H2313**

Dimensions

L = 208

J = 166

N = 23

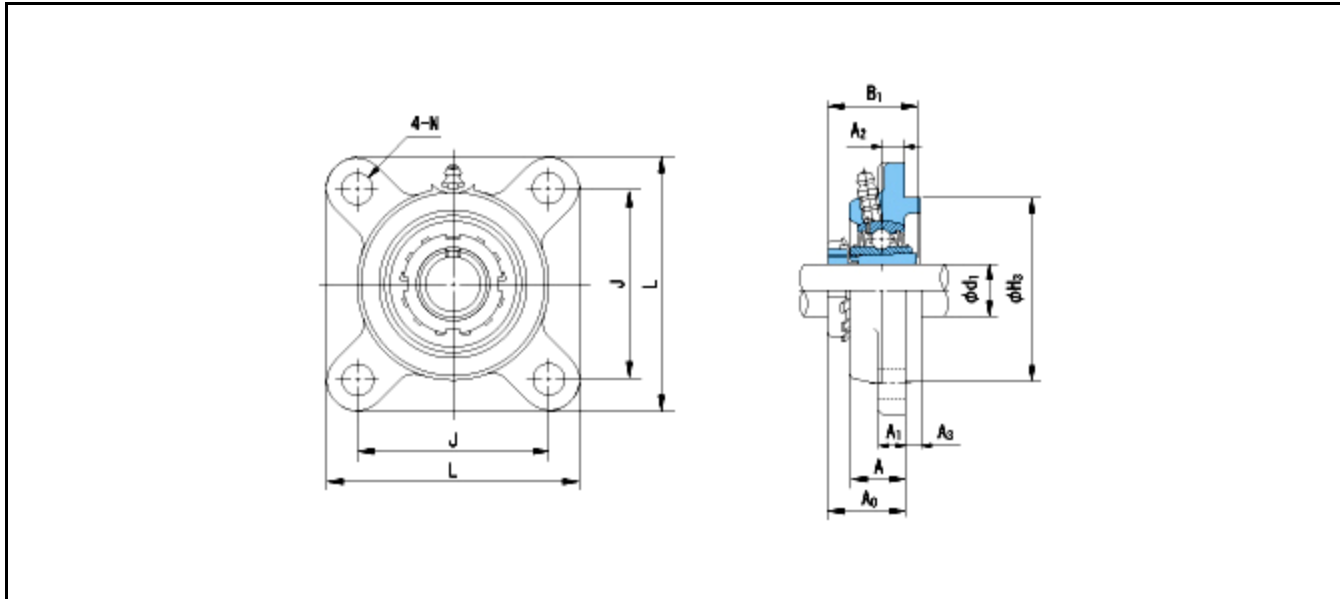

Dimensions

d1 = 60

A1 = 22

A2 = 15

B1 = 65

H3 = 175

A = 40

A0 = 53

Mass = 8.5 kg

Basic Dynamic Load Rating Cr :	92500 N				
Basic Static Load Rating Cor :	59700 N	O.D.Surface Runout with Side :			-
Limiting Speed ;		Axial Runout with Bore :			-
Grease Lubrication :	- rpm	Axial Runout with Raceway :			-
Oil Lubrication :	- rpm	Width Variation :			-
		Radial Runout :			-