

ROECO

# Bearing Data

## Ball Bearing Units

Bearing No. : **UKFLX09C+H2309**

Dimensions

H = 189

L = 116

J = 157

N = 16

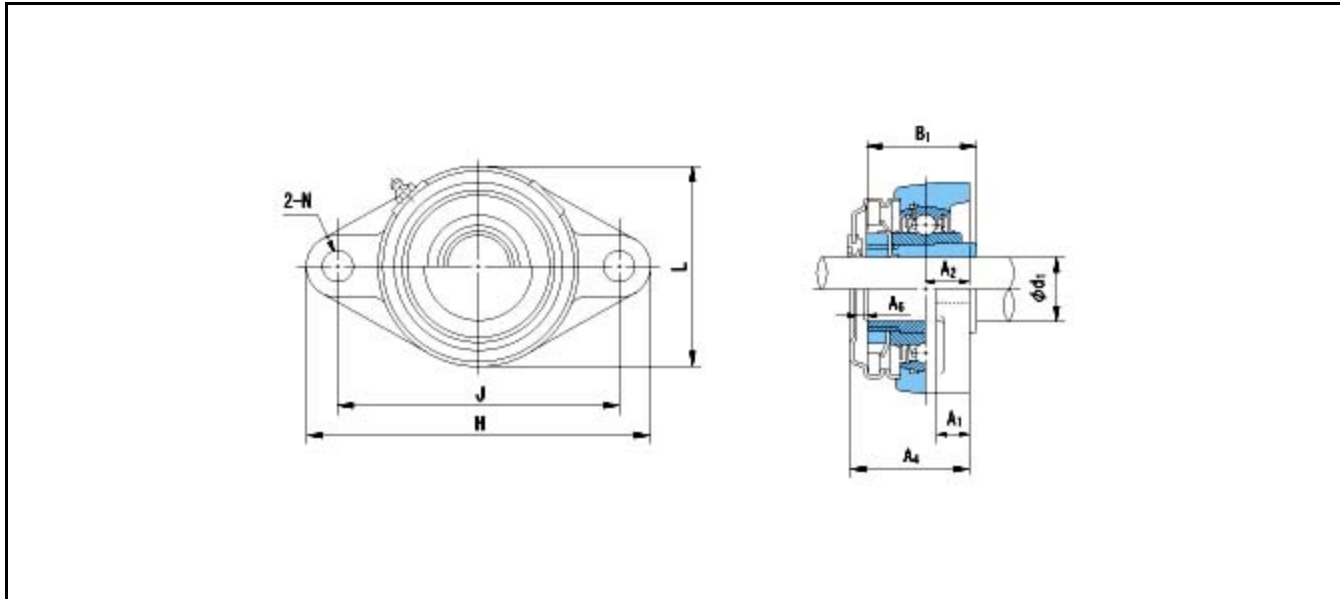

Dimensions

d1 = 40

A1 = 14

A2 = 23

A4 = 67

A6 = 16

B1 = 50

Mass = 2.5 kg

Basic Dynamic Load Rating Cr :	<b>35500 N</b>				
Basic Static Load Rating Cor :	<b>23200 N</b>	O.D.Surface Runout with Side :			-
Limiting Speed ;		Axial Runout with Bore :			-
Grease Lubrication :	- rpm	Axial Runout with Raceway :			-
Oil Lubrication :	- rpm	Width Variation :			-
		Radial Runout :			-