

ROECO

Bearing Data

Ball Bearing Units

Bearing No. : **UKFLX06+H2306**

Dimensions

H = 156

L = 95

J = 130

N = 16

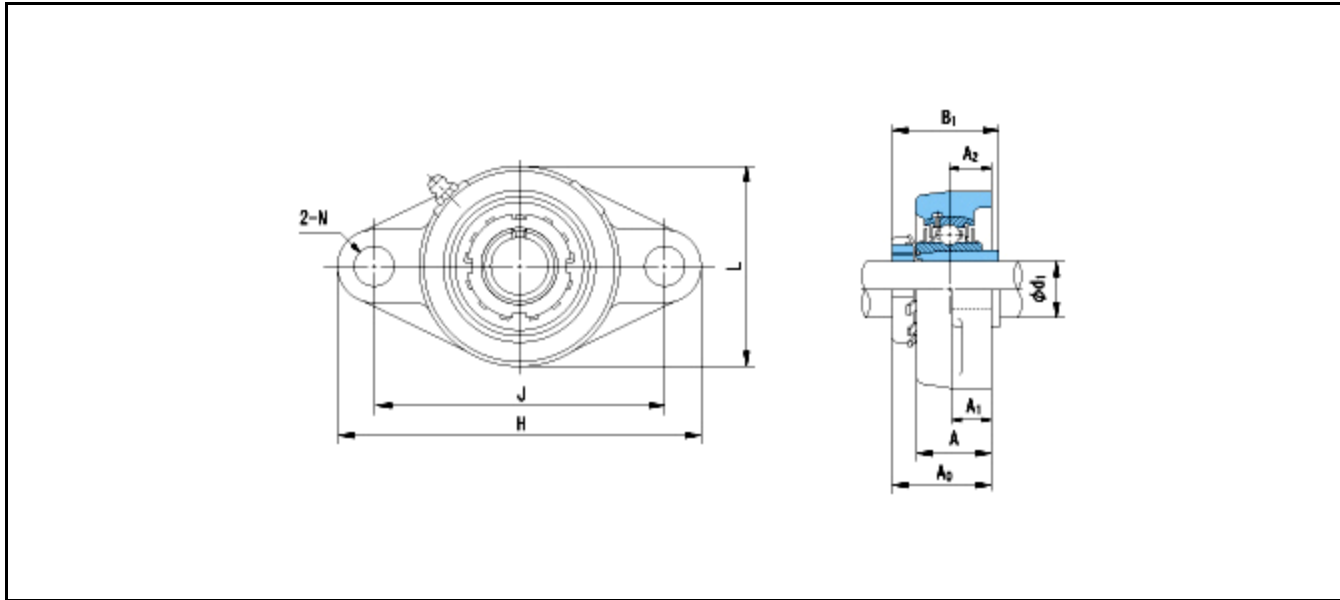

Dimensions

d1 = 25

A1 = 14

A2 = 19

A = 34

A0 = 40.5

B1 = 38

Mass = 1.5 kg

Basic Dynamic Load Rating Cr :	25900 N	INNER RING	OUTER RING
Basic Static Load Rating Cor :	15400 N	O.D.Surface Runout with Side :	-
Limiting Speed ;		Axial Runout with Bore :	-
Grease Lubrication :	- rpm	Axial Runout with Raceway :	-
Oil Lubrication :	- rpm	Width Variation :	-
		Radial Runout :	-