

ROECO

Bearing Data

Ball Bearing Units

Bearing No. : **UKFL317+H2317**

Dimensions

H = 370

L = 220

J = 300

N = 38

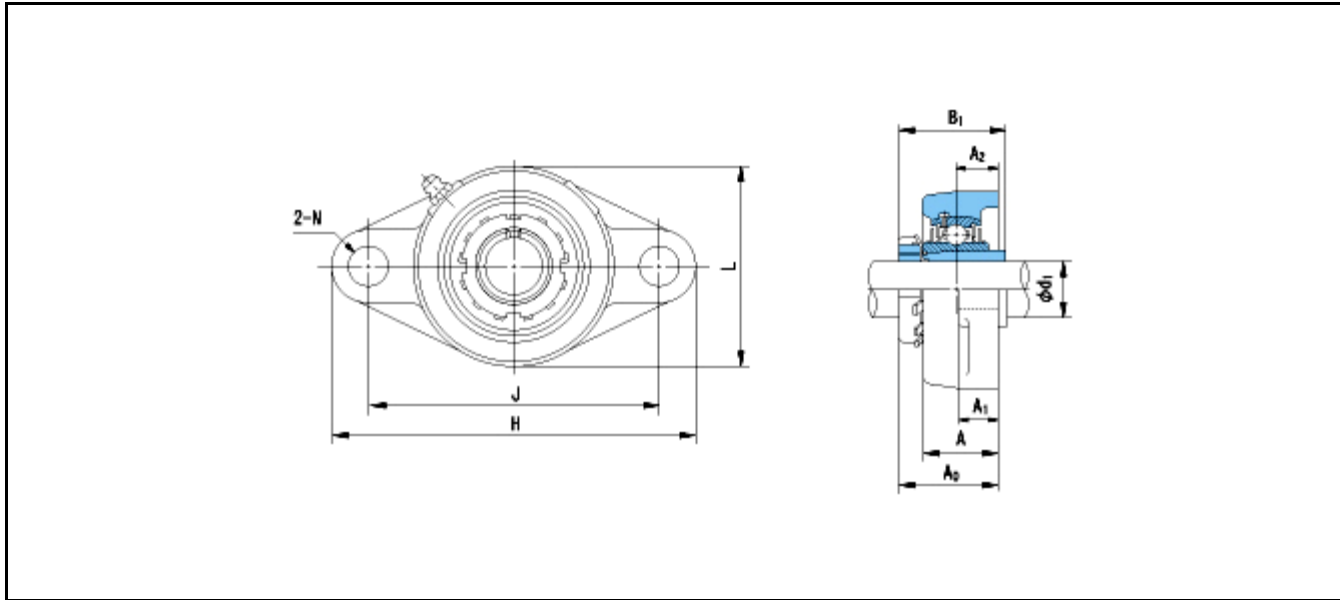

Dimensions

d1 = 75

A1 = 32

A2 = 44

A = 74

A0 = 92

B1 = 82

Mass = 14.5 kg

Basic Dynamic Load Rating Cr : **132000 N**

Basic Static Load Rating Cor : **96500 N**

Limiting Speed ;

Grease Lubrication : - rpm

Oil Lubrication : - rpm

INNER RING OUTER RING

O.D.Surface Runout with Side : -

Axial Runout with Bore : -

Axial Runout with Raceway : -

Width Variation : -

Radial Runout : -