

ROECO

Bearing Data

Ball Bearing Units

Bearing No. : **UKFL308+H2308**

Dimensions

H = 200

L = 112

J = 158

N = 23

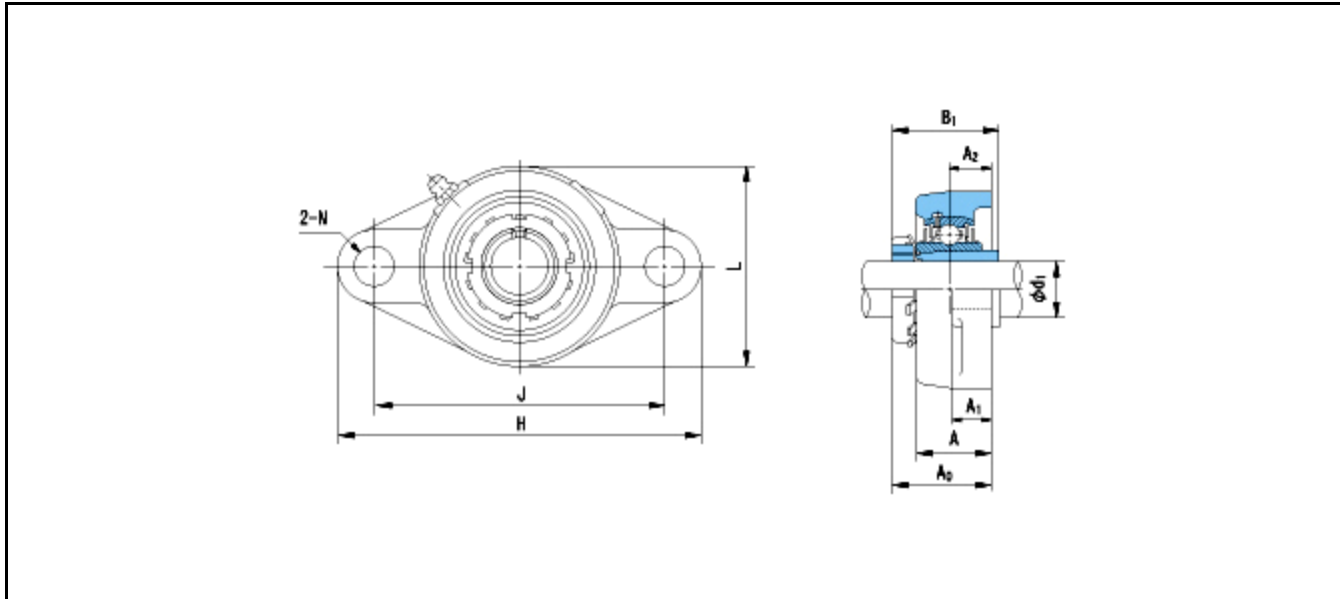

Dimensions

d1 = 35

A1 = 17

A2 = 23

A = 40

A0 = 50

B1 = 46

Mass = 2.5 kg

Basic Dynamic Load Rating Cr :	40500 N	INNER RING	OUTER RING
Basic Static Load Rating Cor :	23900 N	O.D.Surface Runout with Side :	-
Limiting Speed ;		Axial Runout with Bore :	-
Grease Lubrication :	- rpm	Axial Runout with Raceway :	-
Oil Lubrication :	- rpm	Width Variation :	-
		Radial Runout :	-