

ROECO

Bearing Data

Ball Bearing Units

Bearing No. : **UKFL307+H2307**

Dimensions

H = 185

L = 100

J = 141

N = 23

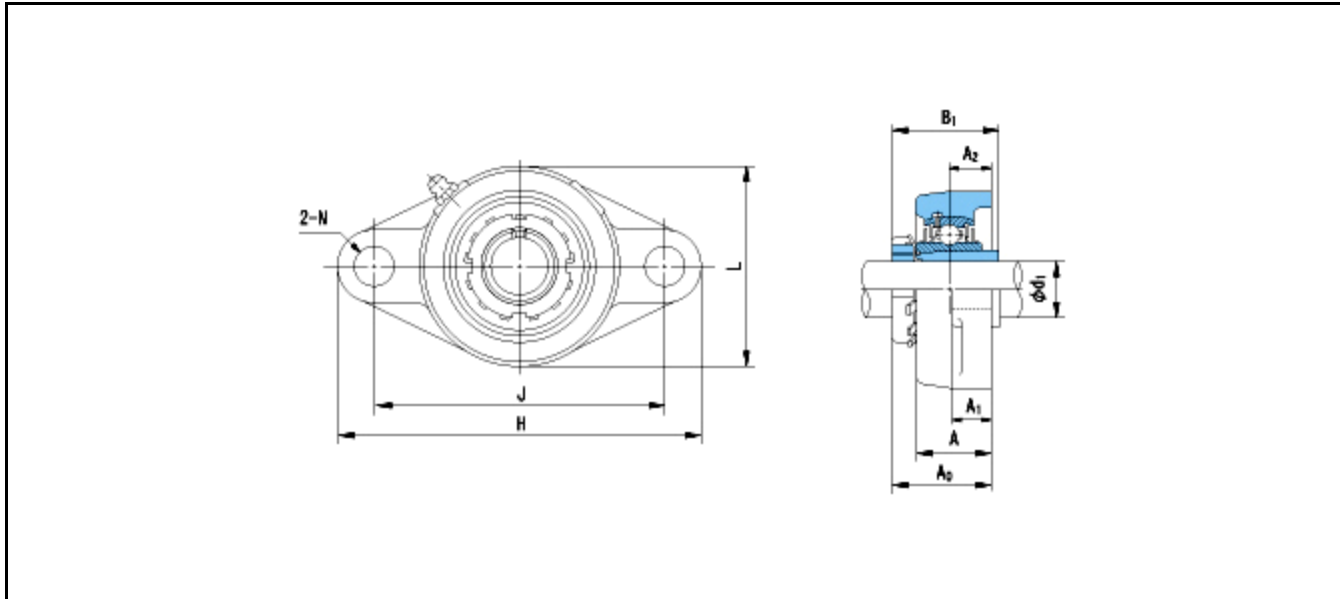

Dimensions

d1 = 30

A1 = 16

A2 = 20

A = 36

A0 = 44.5

B1 = 43

Mass = 1.9 kg

Basic Dynamic Load Rating Cr :	33500 N	INNER RING	OUTER RING
Basic Static Load Rating Cor :	19200 N	O.D.Surface Runout with Side :	-
Limiting Speed ;		Axial Runout with Bore :	-
Grease Lubrication :	- rpm	Axial Runout with Raceway :	-
Oil Lubrication :	- rpm	Width Variation :	-
		Radial Runout :	-