

ROECO

Bearing Data

Ball Bearing Units

Bearing No. : **UKFL211+H2311**

Dimensions

H = 224

L = 130

J = 184

N = 19

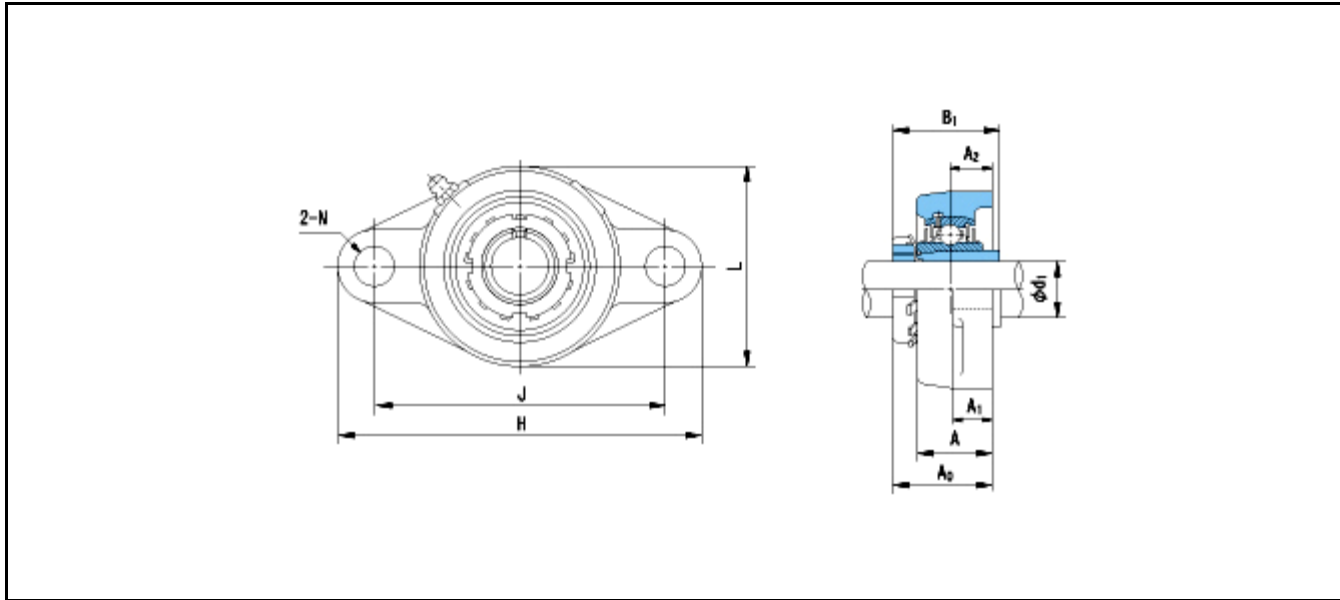

Dimensions

d1 = 50

A1 = 20

A2 = 25

A = 43

A0 = 53.5

B1 = 59

Mass = 3.3 kg

Basic Dynamic Load Rating Cr :	43000 N	INNER RING	OUTER RING
Basic Static Load Rating Cor :	29400 N	O.D.Surface Runout with Side :	-
Limiting Speed ;		Axial Runout with Bore :	-
Grease Lubrication :	- rpm	Axial Runout with Raceway :	-
Oil Lubrication :	- rpm	Width Variation :	-
		Radial Runout :	-