

ROECO

Bearing Data

Ball Bearing Units

Bearing No. : **UKFL210+H2310**

Dimensions

H = 197

L = 115

J = 157

N = 19

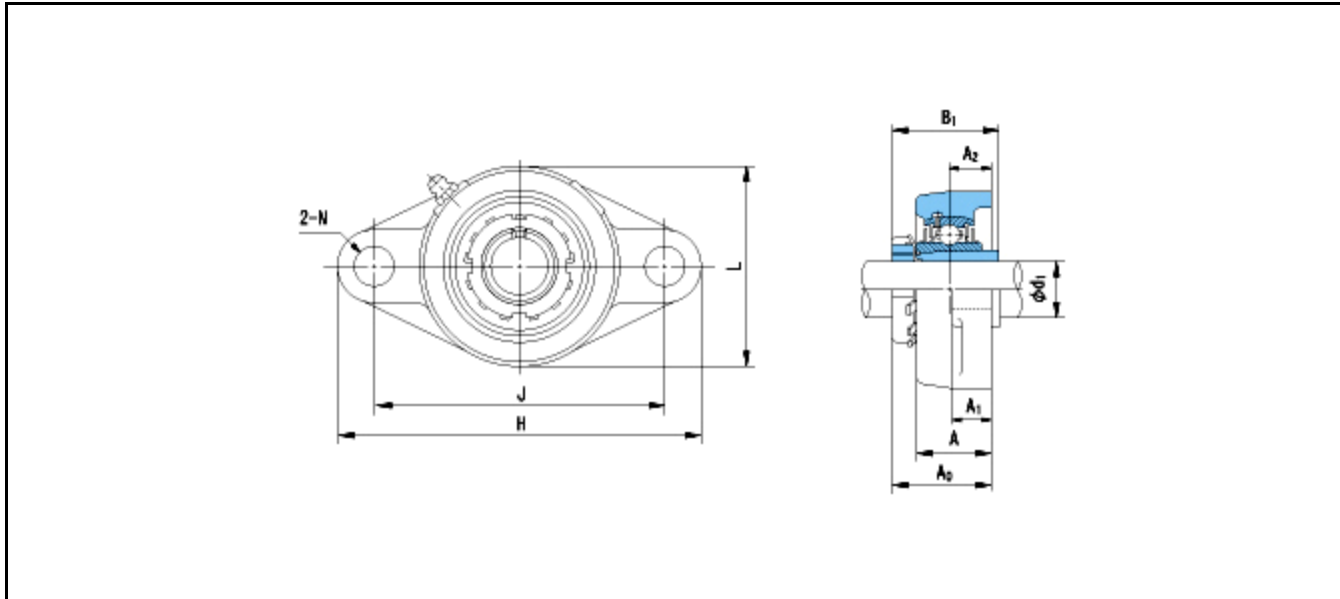

Dimensions

d1 = 45

A1 = 18

A2 = 22

A = 40

A0 = 49.5

B1 = 55

Mass = 2.3 kg

Basic Dynamic Load Rating Cr :	35500 N	INNER RING	OUTER RING
Basic Static Load Rating Cor :	23200 N	O.D.Surface Runout with Side :	-
Limiting Speed ;		Axial Runout with Bore :	-
Grease Lubrication :	- rpm	Axial Runout with Raceway :	-
Oil Lubrication :	- rpm	Width Variation :	-
		Radial Runout :	-