

ROECO

Bearing Data

Ball Bearing Units

Bearing No. : **UKFL209+H2309**

Dimensions

H = 188

L = 108

J = 148

N = 19

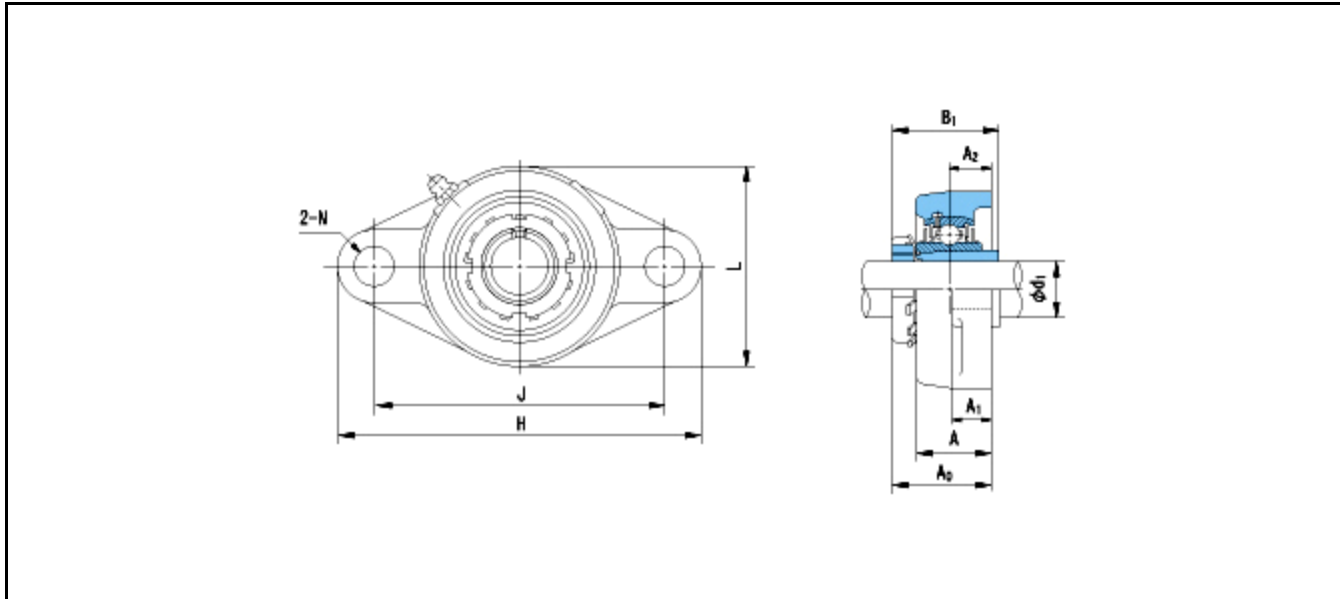

Dimensions

d1 = 40

A1 = 18

A2 = 22

A = 38

A0 = 48

B1 = 50

Mass = 2 kg

Basic Dynamic Load Rating Cr :	33000 N	INNER RING	OUTER RING
Basic Static Load Rating Cor :	20500 N	O.D.Surface Runout with Side :	-
Limiting Speed ;		Axial Runout with Bore :	-
Grease Lubrication :	- rpm	Axial Runout with Raceway :	-
Oil Lubrication :	- rpm	Width Variation :	-
		Radial Runout :	-