

ROECO

Bearing Data

Ball Bearing Units

Bearing No. : **UKFL206+H2306**

Dimensions

H = 148

L = 80

J = 117

N = 16

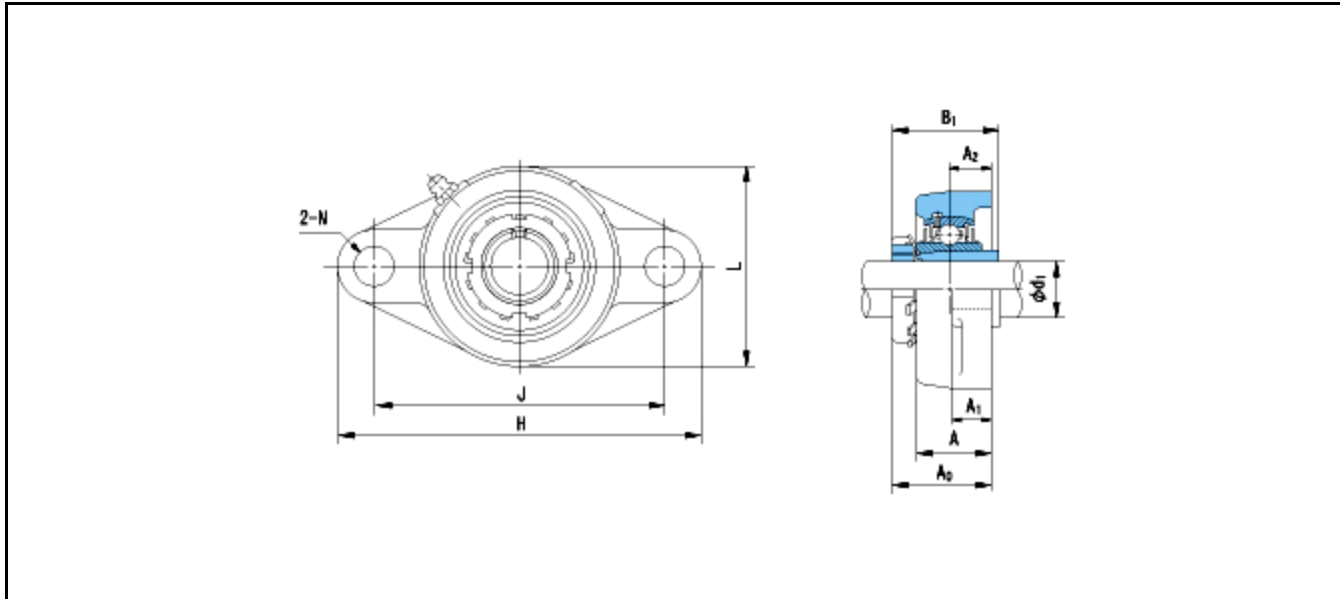

Dimensions

d1 = 25

A1 = 14

A2 = 18

A = 31

A0 = 39

B1 = 38

Mass = 1 kg

Basic Dynamic Load Rating Cr :	19600 N	INNER RING	OUTER RING
Basic Static Load Rating Cor :	11300 N	O.D.Surface Runout with Side :	-
Limiting Speed ;		Axial Runout with Bore :	-
Grease Lubrication :	- rpm	Axial Runout with Raceway :	-
Oil Lubrication :	- rpm	Width Variation :	-
		Radial Runout :	-