

ROECO

# Bearing Data

## Ball Bearing Units

Bearing No. : **UKFL205+H2305**

Dimensions

H = 130

L = 68

J = 99

N = 16

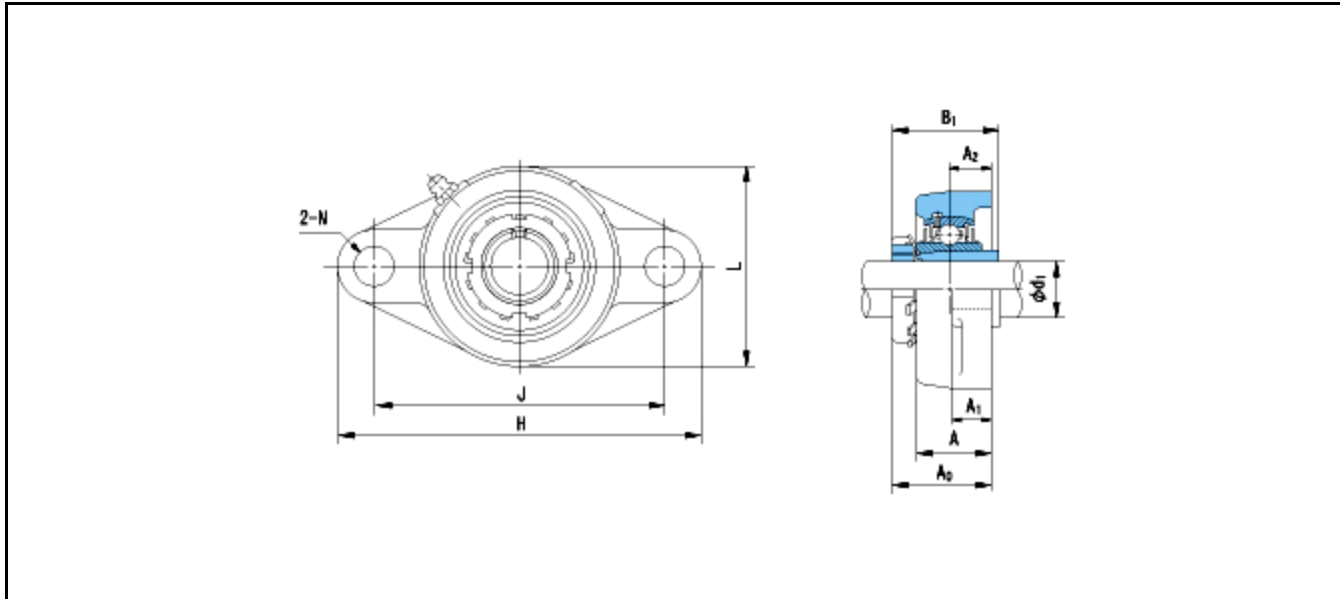

Dimensions

d1 = 20

A1 = 14

A2 = 16

A = 27

A0 = 35.5

B1 = 35

Mass = 0.68 kg

Basic Dynamic Load Rating Cr :	<b>14000 N</b>	INNER RING	OUTER RING
Basic Static Load Rating Cor :	<b>7900 N</b>	O.D.Surface Runout with Side :	-
Limiting Speed ;		Axial Runout with Bore :	-
Grease Lubrication :	- rpm	Axial Runout with Raceway :	-
Oil Lubrication :	- rpm	Width Variation :	-
		Radial Runout :	-