

ROECO

Bearing Data

Ball Bearing Units

Bearing No. : **UKFCX15+H2315**

Dimensions

L = 222

J = 190

N = 19

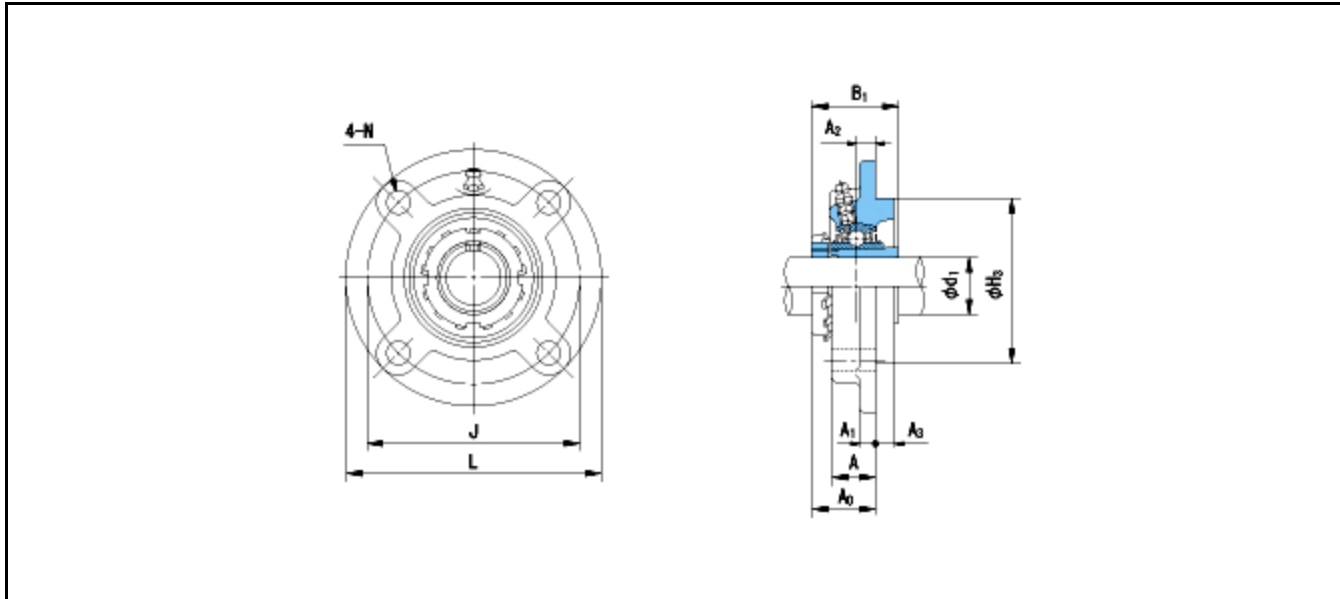

Dimensions

d1 = 65

A = 35

A1 = 16

A2 = 12

A3 = 22

H3 = 164

B1 = 73

A0 = 49

Mass = 7.4 kg

Basic Dynamic Load Rating Cr :	72500 N		INNER RING	OUTER RING
Basic Static Load Rating Cor :	53000 N	O.D.Surface Runout with Side :		-
Limiting Speed ;		Axial Runout with Bore :	-	-
Grease Lubrication :	- rpm	Axial Runout with Raceway :	-	-
Oil Lubrication :	- rpm	Width Variation :	-	-
		Radial Runout :	-	-