

ROECO

Bearing Data

Ball Bearing Units

Bearing No. : **UKFCX08+H2308**

Dimensions

L = 133

J = 111

N = 12

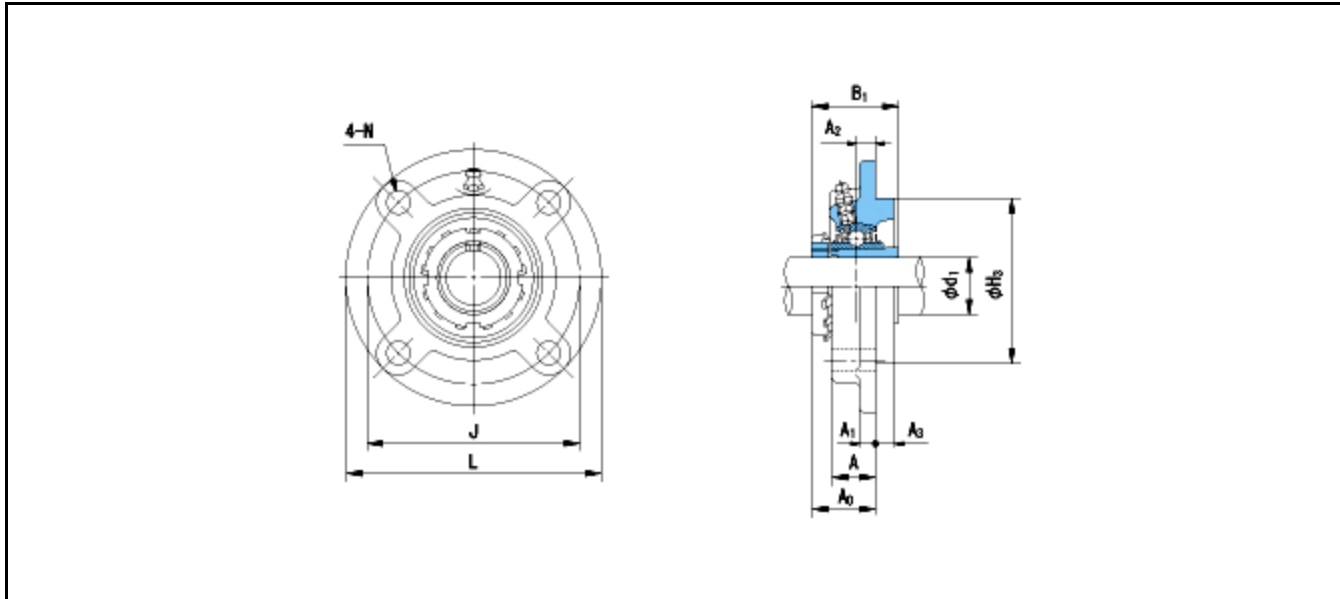

Dimensions

d1 = 35

A = 26

A1 = 11

A2 = 9

A3 = 11

H3 = 92

B1 = 46

A0 = 34

Mass = 1.8 kg

Basic Dynamic Load Rating Cr :	33000 N		INNER RING	OUTER RING
Basic Static Load Rating Cor :	20500 N	O.D.Surface Runout with Side :		-
Limiting Speed ;		Axial Runout with Bore :	-	-
Grease Lubrication :	- rpm	Axial Runout with Raceway :	-	-
Oil Lubrication :	- rpm	Width Variation :	-	-
		Radial Runout :	-	-