

ROECO

Bearing Data

Ball Bearing Units

Bearing No. : **UKFCX07+H2307**

Dimensions

L = 133

J = 111

N = 12

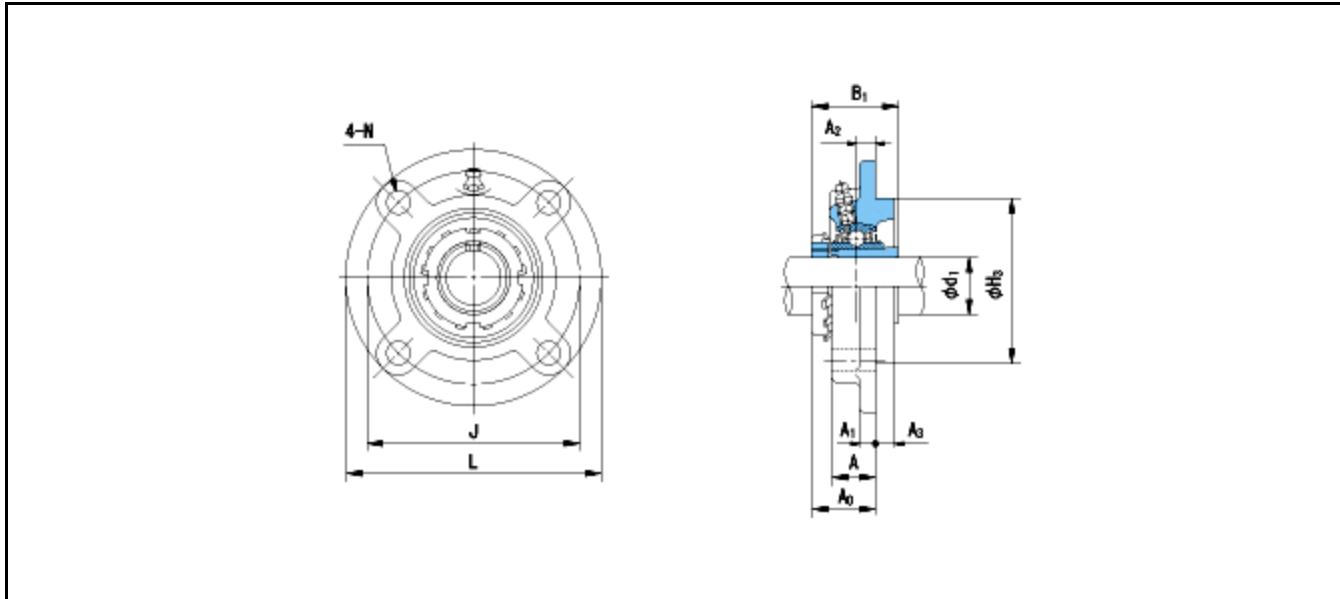

Dimensions

d1 = 30

A = 26

A1 = 11

A2 = 9

A3 = 11

H3 = 92

B1 = 43

A0 = 32.5

Mass = 1.8 kg

Basic Dynamic Load Rating Cr :	29300 N		INNER RING	OUTER RING
Basic Static Load Rating Cor :	17900 N	O.D.Surface Runout with Side :		-
Limiting Speed ;		Axial Runout with Bore :	-	-
Grease Lubrication :	- rpm	Axial Runout with Raceway :	-	-
Oil Lubrication :	- rpm	Width Variation :	-	-
		Radial Runout :	-	-