

ROECO

Bearing Data

Ball Bearing Units

Bearing No. : **UKFC206+H2306**

Dimensions

L = 125

J = 100

N = 12

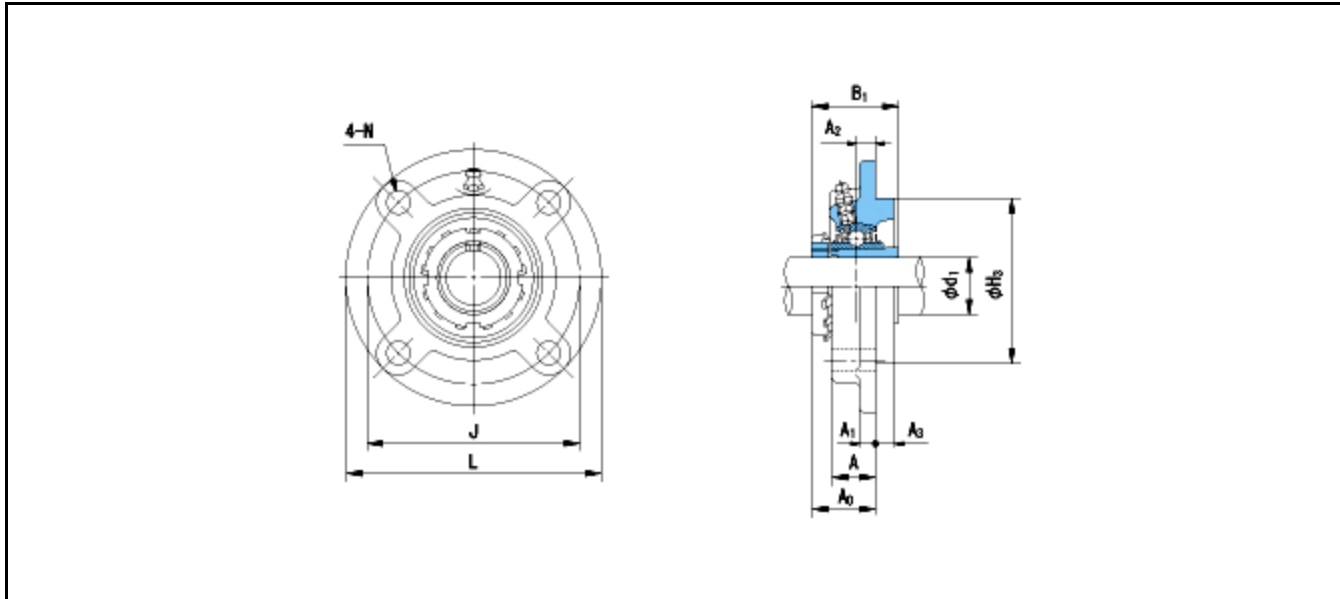

Dimensions

d1 = 25

A = 23

A1 = 8

A2 = 10

A3 = 8

H3 = 80

B1 = 38

A0 = 31

Mass = 1.6 kg

Basic Dynamic Load Rating Cr :	19600 N		INNER RING	OUTER RING
Basic Static Load Rating Cor :	11300 N	O.D.Surface Runout with Side :		-
Limiting Speed ;		Axial Runout with Bore :	-	-
Grease Lubrication :	- rpm	Axial Runout with Raceway :	-	-
Oil Lubrication :	- rpm	Width Variation :	-	-
		Radial Runout :	-	-