

ROECO

# Bearing Data

## Ball Bearing Units

Bearing No. : **UKFC205+H2305**

Dimensions

L = 115

J = 90

N = 12

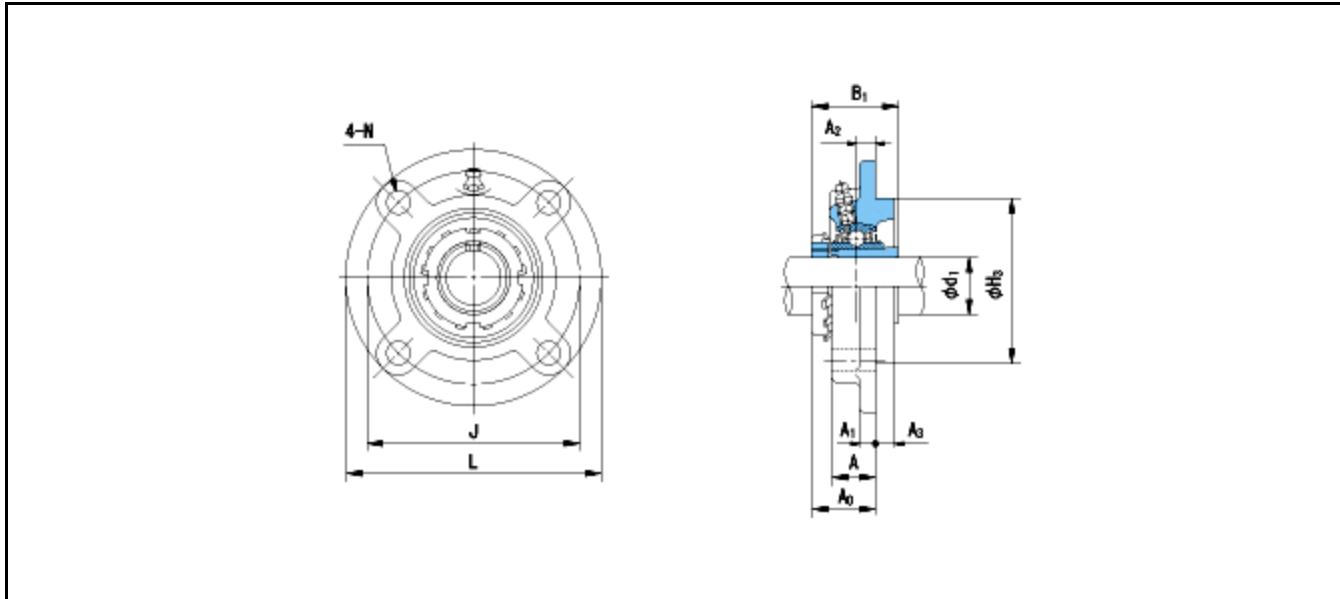

Dimensions

d1 = 20

A = 21

A1 = 7

A2 = 10

A3 = 6

H3 = 70

B1 = 35

A0 = 29.5

Mass = 1.1 kg

Basic Dynamic Load Rating Cr :	<b>14000 N</b>				
Basic Static Load Rating Cor :	<b>7900 N</b>	O.D.Surface Runout with Side :			-
Limiting Speed ;		Axial Runout with Bore :			-
Grease Lubrication :	- rpm	Axial Runout with Raceway :			-
Oil Lubrication :	- rpm	Width Variation :			-
		Radial Runout :			-