

ROECO

Bearing Data

Ball Bearing Units

Bearing No. : **UKF211C+H2311**

Dimensions

L = 162

J = 130

N = 19

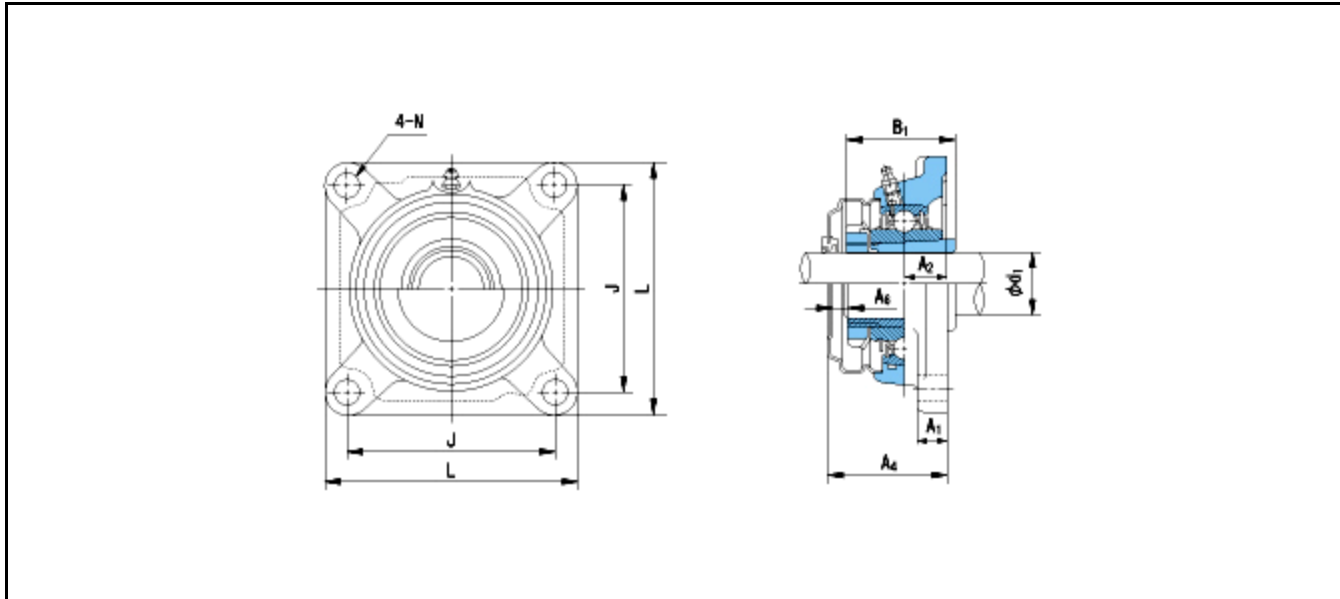

Dimensions

d1 = 50

A1 = 20

A2 = 25

B1 = 59

A4 = 69

A6 = 14

Mass = 3.8 kg

Basic Dynamic Load Rating Cr :	43000 N				
Basic Static Load Rating Cor :	29400 N	O.D.Surface Runout with Side :			-
Limiting Speed ;		Axial Runout with Bore :			-
Grease Lubrication :	- rpm	Axial Runout with Raceway :			-
Oil Lubrication :	- rpm	Width Variation :			-
		Radial Runout :			-