

ROECO

Bearing Data

Ball Bearing Units

Bearing No. : **UKF206C+H2306**

Dimensions

L = 108

J = 83

N = 12

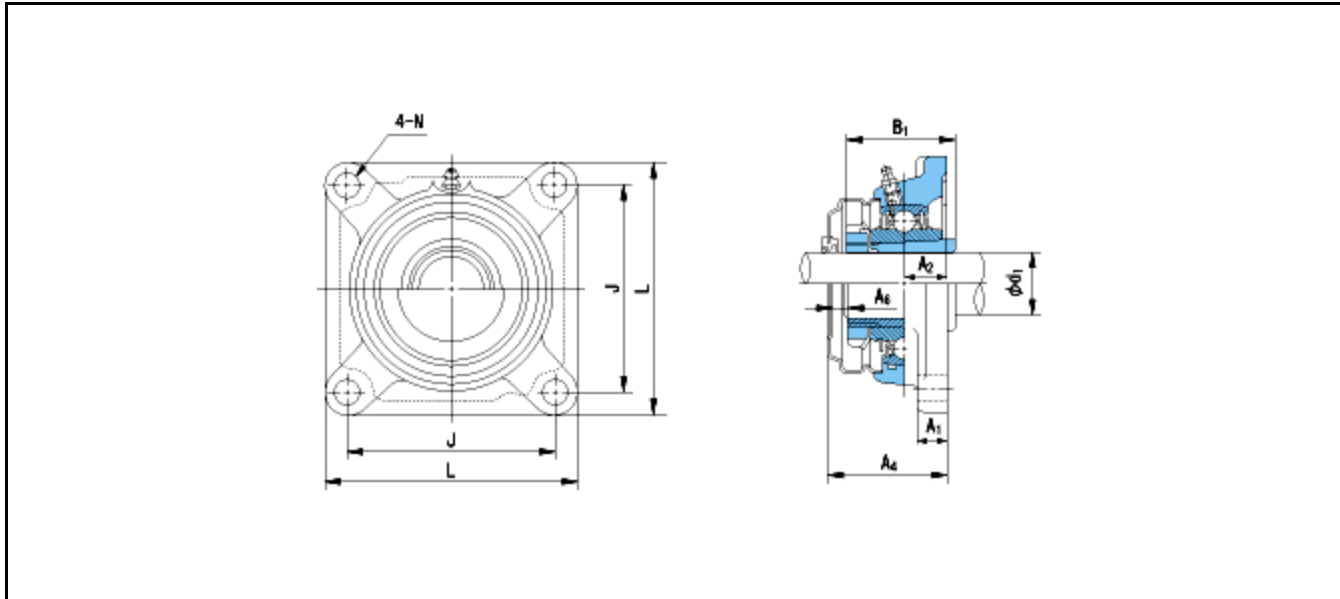

Dimensions

d1 = 25

A1 = 14

A2 = 18

B1 = 38

A4 = 51

A6 = 10

Mass = 1.3 kg

Basic Dynamic Load Rating Cr :	19600 N				
Basic Static Load Rating Cor :	11300 N	O.D.Surface Runout with Side :			-
Limiting Speed ;		Axial Runout with Bore :			-
Grease Lubrication :	- rpm	Axial Runout with Raceway :			-
Oil Lubrication :	- rpm	Width Variation :			-
		Radial Runout :			-