

ROECO

Bearing Data

Ball Bearing Units

Bearing No. : **UKF205+H2305**

Dimensions

L = 95

J = 70

N = 12

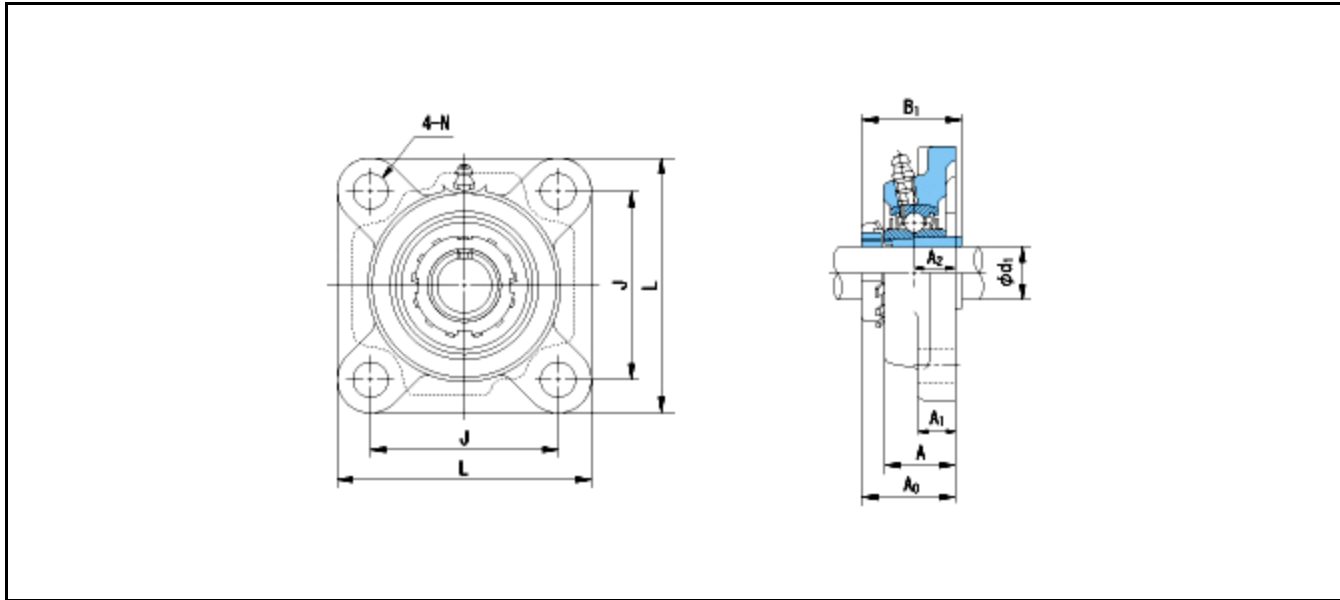

Dimensions

d1 = 20

A1 = 14

A2 = 16

B1 = 35

A = 27

A0 = 35.5

Mass = 0.87 kg

Basic Dynamic Load Rating Cr :	14000 N				
Basic Static Load Rating Cor :	7900 N	O.D.Surface Runout with Side :			-
Limiting Speed ;		Axial Runout with Bore :			-
Grease Lubrication :	- rpm	Axial Runout with Raceway :			-
Oil Lubrication :	- rpm	Width Variation :			-
		Radial Runout :			-