

ROECO

Bearing Data

Ball Bearing Units

Bearing No. : **UK308+H2308**

Dimensions

d1 = 35

d2 = 58

dT1 = 43

B1 = 46

B2 = 10

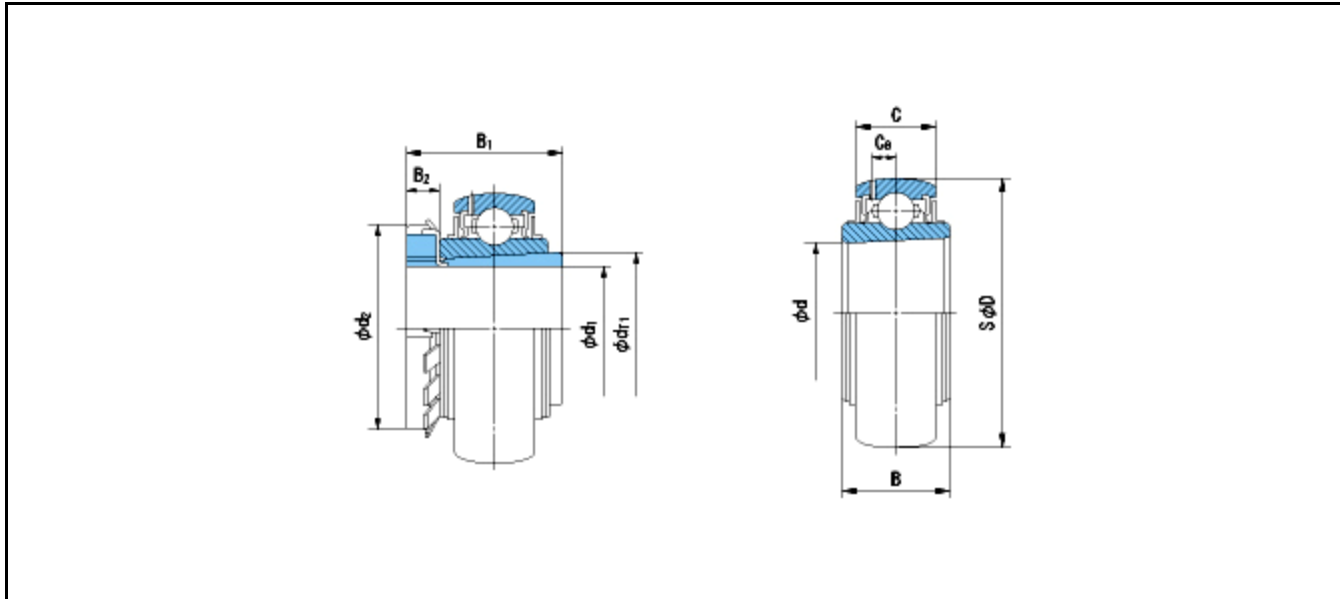

Dimensions

D = 90

d = 40

B = 34

C = 27

Ca = 8.2

Mass = 1.01 kg

Basic Dynamic Load Rating Cr :	40500 N		INNER RING	OUTER RING
Basic Static Load Rating Cor :	23900 N	O.D.Surface Runout with Side :		-
Limiting Speed ;		Axial Runout with Bore :	-	-
Grease Lubrication :	- rpm	Axial Runout with Raceway :	-	-
Oil Lubrication :	- rpm	Width Variation :	-	-
		Radial Runout :	-	-