

ROECO

Bearing Data

Ball Bearing Units

Bearing No. : **UK213+H2313**

Dimensions

d1 = 60

d2 = 85

dT1 = 69.5

B1 = 65

B2 = 14

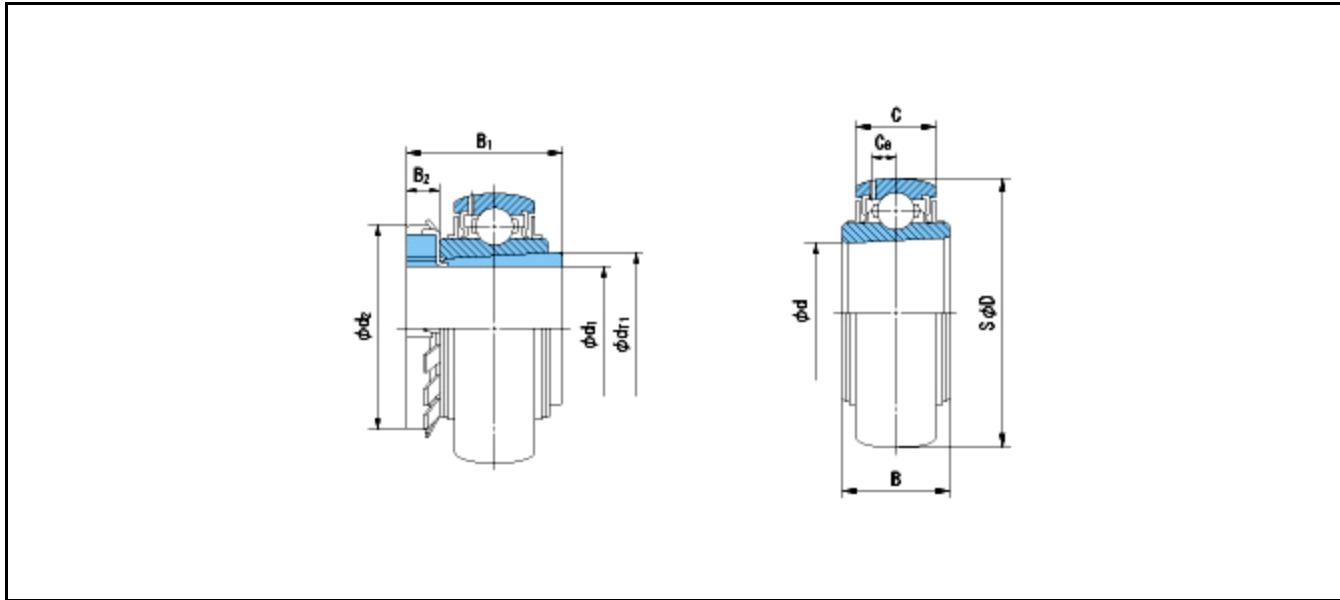

Dimensions

D = 120

d = 65

B = 38

C = 27

Ca = 8.3

Mass = 1.82 kg

Basic Dynamic Load Rating Cr :	57500 N		INNER RING	OUTER RING
Basic Static Load Rating Cor :	40000 N	O.D.Surface Runout with Side :		-
Limiting Speed ;		Axial Runout with Bore :	-	-
Grease Lubrication :	- rpm	Axial Runout with Raceway :	-	-
Oil Lubrication :	- rpm	Width Variation :	-	-
		Radial Runout :	-	-