

ROECO

Bearing Data

Ball Bearing Units

Bearing No. : **UK209+H2309**

Dimensions

d1 = 40

d2 = 65

dT1 = 48.5

B1 = 50

B2 = 11

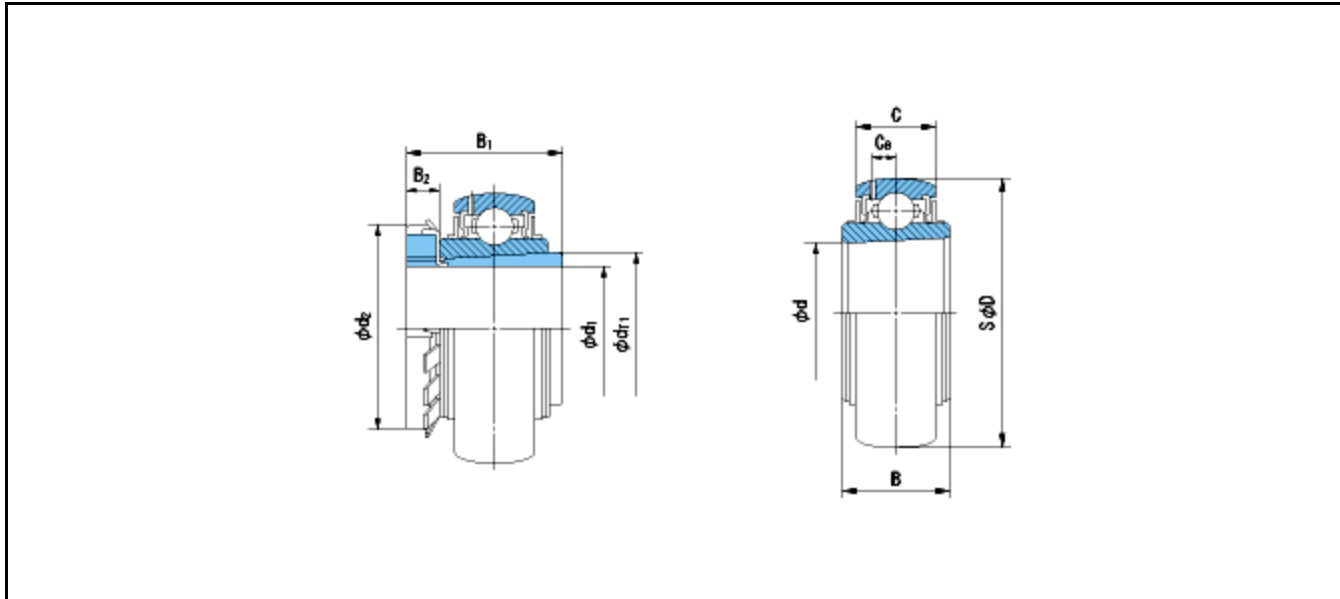

Dimensions

D = 85

d = 45

B = 30

C = 22

Ca = 6.5

Mass = 0.77 kg

Basic Dynamic Load Rating Cr :	33000 N		INNER RING	OUTER RING
Basic Static Load Rating Cor :	20500 N	O.D.Surface Runout with Side :		-
Limiting Speed ;		Axial Runout with Bore :	-	-
Grease Lubrication :	- rpm	Axial Runout with Raceway :	-	-
Oil Lubrication :	- rpm	Width Variation :	-	-
		Radial Runout :	-	-